

# CDIO Worldwide Challenge

---

MEng Group Project



Group J

Gareth Deering

Jorge Guadalupe Fernández

Gemma McCallion

Andrew McGregor

Calum Middleton

Sabrina Ralph

Website URL - <http://xn--y-2fa.no/sab/#future>

## **Abstract**

The 2015 CDIO (Conceive, Design, Implement, Operate) challenge called for the design and build of a folding bicycle that was to be shown and competed at the CDIO Regional Competition on 2<sup>nd</sup> May 2015. The bike had to be of a lightweight and innovative design that could be folded to a size that would allow city commuters to use it with ease.

The first stage of the project was to research the existing market and find a gap that could be filled. It was found that there is a lack of electrically assisted folding bicycles with 20" wheels. Using this information, a number of different concepts were generated and using Pugh's Total Design process, a final design was found. This design included the desirable electrical assistance as well as a unique 'slide and fold' system for folding that allowed for a small folded size.

From here, Solidworks and ANSYS were used to bring the design to life and allowed a functioning prototype to be manufactured. Following testing to ensure ANSYS was accurate; this prototype will be taken to the CDIO Regional Competition.

## Acknowledgements

The group would like to acknowledge the following people for their help during the project.

Professor Jim Boyle for his continuous help and support throughout the project.

Mr Steven Black and Mr Andrew Irvine for his invaluable help during the building phase.

Mr Jim Docherty for the help in ordering all of the components and materials needed to build the bike.

All of the people who replied to the survey, without their responses we wouldn't have had the base knowledge on what the consumer wants.

Engineering Faculty and the Department of Mechanical and Aerospace Engineering at University of Strathclyde for the extra funding that allowed us to build the bike to a high specification and also to travel to the competition. Specifically we would like to thank Dr. Gayle Wilson and Professor Donald Mackenzie for arranging the additional funding.

Dr Tugrul Comlekci for help with ANSYS and the licencing issues we faced.

CDIO initiative for allowing this project to take place and for the opportunity to travel to the regional competition day at Queens University, Belfast.

# Contents

Abstract.....	i
Acknowledgements.....	ii
1.0 Introduction .....	1
2.0 Project Brief and Plan.....	2
2.1 Project Brief .....	2
2.2 Project Plan .....	2
3.0 Risk Assessment .....	3
3.1 Computer Skills .....	4
3.2 Budget Management .....	4
3.3 Time Management.....	4
4.0 Group Dynamics.....	4
5.1 Existing Market .....	5
5.2 Consumer Survey .....	5
5.3 Regulations.....	6
5.3.1 Government Regulations .....	6
5.3.2 Public Regulations.....	6
5.4 Research Conclusions.....	7
6.0 Pugh’s Total Design Process.....	7
6.1 Statement of Requirements.....	8
6.2 Product Design Specification (PDS).....	8
6.3 Concept Generation .....	9
7.0 The Final Design .....	12
7.1 Material Investigation .....	12
7.2 Bending calculations .....	15
7.3 CAD.....	16
7.3.1 Solidworks .....	16
7.3.2 ANSYS.....	19
8.0 Funding .....	25
9.0 Business Case Plan .....	26
10.0 Website .....	28
11.0 Purchasing.....	29
12.0 Manufacture .....	30
12.1 Rear Triangle .....	30

12.2 Front Forks and Handlebars.....	30
12.3 Top Tube .....	31
12.4 Finished Prototype .....	31
13.0 Competition .....	32
14.0 Conclusions .....	33
14.1 The Group Dynamic .....	33
14.2 The Project .....	33
14.3 The Project Management .....	34
14.0 References .....	34
Appendix 1 – Project Plan and Gantt Chart .....	36
Appendix 2 -Group Availability .....	38
Appendix 3 – Time Spent on Project as a Group .....	39
Appendix 4- Existing Products.....	40
Appendix 5 – Consumer Survey and Results.....	42
Appendix 6 – Initial Concepts .....	45
Appendix 7- Convergence matrix 1.....	49
Appendix 8: Handlebars for bending calculations .....	51
Appendix 9 – Costing Spreadsheet .....	52
Appendix 10-Manufacturing Gantt Chart .....	54
Appendix 11 – Engineering Drawings .....	55
Appendix 12- Finished Bicycle.....	56

## 1.0 Introduction

As the major cities of the world continue to develop at a rapid rate, the effect of global warming through carbon emissions is having a major effect on the environment and thus the population. To reduce this, strict carbon emission targets were set for all major cities. Many governments believe the best way to meet these targets is to impose a tax on high carbon emission vehicles to persuade commuters to use more environmentally friendly means of travel; for example public transport, walking or cycling. Urbanisation is leading to cities becoming more crowded thus increasing travel time of commuters. It was also found that the majority of urban car journeys involve just a single person, which leads to increased levels congestion and also puts pressure on parking infrastructure.

Therefore, a bicycle was believed to be the best solution to the problems of congestion, parking and reducing carbon emissions. However, the limited availability of storage space in city apartments and train/bus stations led to another problem. However this problem of lack of suitable storage space can be easily resolved by the use of folding bicycles. For these reasons, the purpose of this project was to design and construct a folding bicycle for the urban commuter using the CDIO (Conceive-Design-Implement-Operate) framework.

From the initial brief, a project plan was drawn up to include the aims and objectives of the report. A schedule was also completed to give structure to the group approach and thus assure the best use of time and resources. Market research was undertaken to assess what products were already available and to determine what the consumer really wanted/needed from such a product. From these results, a statement of requirements based on Pugh's Total Design Process was generated along with a number of concepts (section 6). Through this concept generation and regeneration a final concept was chosen (section 7) which best reflects the needs of the market.

## 2.0 Project Brief and Plan

### 2.1 Project Brief

It was stated that an innovative folding bicycle was to be designed and constructed that had the ability to complete an urban commute, including the use of buses and trains. The bicycle should be compact, lightweight and aesthetically pleasing. The functional prototype was then to compete in a CDIO Regional Competition on 2<sup>nd</sup> of May 2015 where it would undergo a number of real world tests. These tests would mimic the type of conditions that would likely be faced on a typical urban commute. A number of milestones were also given within the initial brief. These were the major tasks required for the project to be successful and complete the main aim of reaching the competition in May.

- Carry out research into the existing fold up bike market
- Full design study to identify suitable concept
- A design / project report
- CAD design and FEA of production chassis
- CAD model and visualisation of bodywork and full assembly
- Secure additional funding if university allocation is not enough
- Interim Group Report (will include a summary of the completed aforementioned tasks)
- Submission of drawings for engineering workshop
- Final Group Report
- Manufacture and test prototype ready for competition (estimated to start build end of February/start of March and be completed before May exam diet)
- Individual Critique
- Produce a business case plan for pitching to venture capitalists
- Create a website
- Presentation to group project board
- Function prototype competition day

### 2.2 Project Plan

With all of this information, a detailed project plan was created in Microsoft Project; a dedicated project-planning software. It automatically generates a Gantt chart from the inputted information and by indicating which tasks must be complete before another can begin, a critical path for the whole project can be drawn up.

The first stage was to put in the major tasks, i.e. the research, conceptual design stages etc. Within these major tasks, minor tasks within each are entered to add more detail to the overall plan and allow every single aspect of the project to be timetabled. This gives an accurate timeline, ensuring that the project will stay on schedule and preventing individuals from not doing their assigned work. Task progress is kept up to date with the percentage complete column to ensure individual tasks are completed on time. The project plan is shown in Appendix 1.

With the project plan complete, it was easier to see the number of tasks that had to be divided up at each point. This was done very democratically with each member of the group choosing which task/tasks they would ideally do. If a conflict – such as one member particularly not wanting to do a certain task – arose, another member would swap their task and a compromise would be made. This did not cause any major problems and group harmony remained good throughout.

Another important aspect in dividing up the tasks was the availability of group members during the week (Appendix 2). Due to classes and other commitments some members would not have as much free time to dedicate to work as others. At these times, bigger tasks were assigned to the group members with most free time. However those who only had small tasks ensured they did their fair share of work at other stages. These aspects are discussed further in section 4.

### 3.0 Risk Assessment

One of the first tasks carried out was a risk assessment. This allowed the group to evaluate any and all risks that were likely to come up during the project. It would then be easier to deal with these risks since plans would already be in place to alleviate them.

- Possibility of not getting it built in time due to lab restrictions and technician availability.
  - Preventative measures included the group completing as much preparation of parts as possible before submitting to the workshop.
  - The manufacturing team completed as much manufacture as they could themselves to minimise workshop time.
- Budget may not stretch to buying all parts for bicycle and extra funding may be hard to come by.
  - Preventative measures included starting looking for funding early.
  - A full cost estimation was created to validate requests for additional funding (see section 8).
- Parts getting lost in the post or not being suitable. Sourcing suitable materials could be challenging.
  - Parts were ordered as early as possible once funding was received
- May not make it to CDIO competition due to prototype not being finished or because of competition date changes.
  - Preventative measures included monitoring progress on project plan and regularly consulting with the supervisor about any changes to competition arrangements.
- Group coordination and scheduling. Exam and work pressure, injury, illness.
  - Progress was monitored and aligned with the project plan.
  - If some group members were struggling with workload, others would take on more for a short period under the understanding that the favour would be returned.
- University closures due to natural or man-made disasters, e.g. snow closure or fire.
- Accidental patent infringement. Major implications if this happens.
  - Ensured no patents were infringed upon.



### **3.1 Computer Skills**

Any engineering design and build project will include a large amount of computer modelling and simulation. All group members believed that the standard CAD software used by the university, PTC Creo, was not particularly user friendly so the decision was made to use Solidworks instead. One member of the group was particularly skilled in this software so they were able to pass on their knowledge to the rest of the group. However, it was still a time consuming process for the rest of the group to gain enough experience to produce the models needed.

Solidworks also allows easy export to ANSYS, where all of the analyses were carried out. Again, one member of the group was able to aid the other members in learning how to use the software correctly.

### **3.2 Budget Management**

With the limited budget given by the university, it was felt that one member of the group would be in charge of all things to do with money. This ensured that all spending was tracked and remaining budget kept up to date throughout the project. This person was also responsible for sourcing and managing additional funding to ensure the project was completed to as high a standard as possible.

### **3.3 Time Management**

With such a large scope for the project, it was important that enough time was spent on the project each week to keep it progressing and ensure that the group did not get behind the schedule created in Microsoft Project. As mentioned previously, each group member's weekly availability was documented (Appendix 2) and from this an overall time available document was generated. Although there was a potential to work for a total of 2 hours per day on the project, this was not viable since every group member had numerous other projects and assignments that required attention as well. The actual amount of time spent per week on this project as a whole group is shown in the chart in Appendix 3. Much more time was spent individually and within subgroups discussed in the following section.

## **4.0 Group Dynamics**

In the initial stages the group developed a keen work ethic and drive for the project. It was clear from the start the group worked well together and had similar focus, this proved beneficial in the design stage of the process. The group decided that there would not be a dedicated team leader. However, the person with the most interest and experience at each particular stage took on a supervisory role at that point, ensuring that the tasks were completed effectively regardless of the lack of a general leading group member.

The design stage, under taken in the first semester starting with research through the design process to the final design, was on a whole under taken by the entirety of the group. The phases of the process were generally rather large and so majority of tasks were divided evenly, at the end of each phase there were group meetings to combine the work done by group members and organise the subsequent phase.

Alongside the design of the bicycle some group members took on additional roles. Calum had experience of Microsoft Project so became group coordinator, keeping the project plan up to date and organising group meetings. This role was sustained throughout the project.

Once the design stage was completed the group dynamic changed as there were too many tasks to be undertaken as a whole. This promoted the creation of sub teams in different fields; technical, business and coordination. This dynamic tended to require more leadership than in the previous semester.

Gareth's involvement with outside sources and the university over funding and competition purposes lead to him becoming the team leader. The business sub team comprised of Gareth and Sabrina, creating a business plan for the bicycle and securing additional funding due to their keen interest in this field. The Coordination sub team included Calum and Sabrina. Their tasks included the organisation of group meetings, designing and making the website and the writing of the report. The technical sub team was in fact two teams; one involved in the CAD design and structural analysis of the design and the other manufacturing of the prototype. The software team comprised of Gemma, Andrew and Jorge with the task of building the CAD model and analysis through ANSYS to ensure the feasibility of the design. The manufacture was undertaken by a team of Andrew, Gareth and Gemma who were responsible for the construction of the bike.

## 5.1 Existing Market

One dilemma in designing a folding bicycle was that the market is already somewhat saturated due to the recent increase in popularity for such bicycles. Dahon, an American company, currently dominates the folding bicycle market and has had increasing revenue and sales over recent years (Carey, 2006) (Dahon Reports Steady First Half Growth, 2009). The use of folding bicycles is growing worldwide, particularly in Asia where folding bicycle sales account for approximately 30% of the bicycle market (Van Shaik, 2013). The UK Department of Transport has also recently doubled cycle funding to £374m and coupled with match-funding, it has reached £622m which will be invested in improving infrastructure for cyclists on the road (Politics, 2014). Thus it can be said that there is definitely a demand for folding bicycles and very likely that their popularity will continue to grow in the UK. Advances in folding bicycle innovation could only help to further increase its status as an everyday mode of transportation.

Taking a look at what is available on the market now, there are a number of existing folding bicycles at a reasonable price point (£110±10) and there are some electric folding bikes albeit they are much more expensive (£500+) as illustrated in Appendix 4.

## 5.2 Consumer Survey

The group generated a consumer survey on Google Docs Forms. The survey (Appendix 5) primarily reached out to those in the 18-30 year old age range which encompasses students and young professionals. This was done by posting it to a number of public forums (Facebook, Reddit). With 84 responses received, the results were collated into the tables and charts shown in Appendix 5. The most commonly used modes of transportation (used alone or in tandem) were: bicycle (29%), bus (30%), car (33%) and walking (41%); and most commutes ranged from 1-10 miles (58%). Given that a significant number of responses used multiple modes of transportation, it correlates to a preference

for a backpack or rolling trolley method of carrying the folding bike. Majority of responses (45%) preferred a backpack which indicates that consumers are expecting a very lightweight product. At the same time, consumers are not expecting to pay an extravagant sum of money for a folding bike (92% would want to pay less than £500).

From the responses, people expected to have a frame that can be extremely small when folded and which is quick to fold (less than a minute of folding time). The preferred wheel size was 20" which puts the bicycle in a moderately compact frame regime. Incorporating an electric motor with mechanical pedalling was second most popular to mechanical pedalling alone (42% and 53% respectively).

## 5.3 Regulations

As the bicycle was to have an electrical assisted pedal system in addition to being taken on public transport, government and public transport regulations has to be taken into account.

### 5.3.1 Government Regulations

UK Government regulations for electric bicycles (Government, 2014):

- Bicycle must have pedals that can be used to propel it
- Electric motor should not be able to propel the bike when traveling more than 15mph
- Bicycle (including its battery but not rider) must not be heavier than 40 kg if single person bicycle or 60 kg if tandem or tricycle
- Motor should not have a maximum power output of 200+ watts or 250+ watts if tandem or tricycle
- Bicycle must have a plate showing the manufacturer, the nominal voltage of the battery, and motor power output
- Must be government approved

### 5.3.2 Public Regulations

Public transport restrictions were also researched in detail (Bikes on public transport, 2014):

Generic Sizes

- 90x70x30cm
- Under 50kg
- Can be refused if larger than 100cm in any direction
- 20" wheel size

Megabus

- Cycles only permitted on an East Midlands Trains Service with valid reservation
- Folding cycles can be carried on any MegaTrain as long as they remain folded during trip

Lothian Buses

- Only folding bicycles are permitted if fully enclosed in a carrying bag
- Any battery from which corrosive liquid might leak is not permitted

Virgin Trains

- Folding bicycles are free and do not require a reservation (unlike regular bicycles)

Euro Star

- Free up to 85cm<sup>2</sup>

*Other trains that require a container:*

C2C, Docklands Light Railway, ScotRail, Southwest Trains, Greater Anglia, First Capital Connect (must fold before ticket barrier)

*Trains with size restrictions:*

London overground (must not exceed 2m), First Great Western (18' wheel size), East midlands (must fit into luggage racks)

*Trains with no restrictions:*

Arriva Trains Wales, Chiltern, Cross country Trains, East coast, Trans Pennine Express, Grand Central Trains, Greater Anglia, Heathrow Connect and Express, Hull, Island Line, London midland, Mersey rail, Northern rail, Southeastern, Southern, Southwest trains, Trans link.

## 5.4 Research Conclusions

After surveying the market, it seems that users place a large emphasis on having a bicycle that is similar to a normal bicycle in terms of feel despite some size compromises (i.e. a 20" wheel is somewhat compact). The user is likely to use the bicycle to move to and from public transport or a car park, suggesting the bicycle should be quick and intuitive to fold into a small volume to adhere to train company restrictions. Therefore, "compact-ability" is a main driver in design considerations and each potential design should primarily be judged on the following functions:

- How much it rides like a typical bicycle,
- How easy it is to fold,
- How small it is when folded,
- How convenient it is to carry.

From the research conducted the group found a gap in the market in the form of affordable electric folding bicycles and for this reason it was decided that the bicycle would include an electric motor to assist pedalling. Other features of the design (i.e. materials, gearing, wheel rims, etc.) can be discerned with respect to how well it functions based on these aspects.

A detailed product specification was created using Pugh's Total Design (section 6) based on the results gathered from the market analysis.

## 6.0 Pugh's Total Design Process

Pugh's total design is described as;

*"The systematic activity necessary, from the identification of the market/user need, to the selling of the successful product to satisfy that need - an activity that encompasses product, process, people and organisation."*

And with engineering design being;

*"The organised, thoughtful development and testing of characteristics of new objects that have a particular configuration or perform some desired function(s) that meet our aims without violating any specified limitations."*

The process revolves around the 'Design Core'. From this, a 'Project Design Specification' can be created, which is then used to compare concepts in a 'Controlled Convergence Matrix'.

## 6.1 Statement of Requirements

From the market research, it was decided to design and build a lightweight pedal bicycle with electric option to assist the user. The bicycle was to be folding to allow for transportation on trains and buses as part of the day to day urban commute. The folded bicycle was to be compact and easy to carry to meet the market demands and also have an aesthetically pleasing finish to interest potential customers. A wheel size of 20 inches was chosen as this was the maximum wheel size allowed for train and bus transportation and still enables the bicycle to function in a similar way to that of a standard bicycle. As the average commute was approximately 10 miles, the range from the electric motor needed to be capable of lasting at least this distance, with an average charge time of 4 to 6 hours. The folding and unfolding time was to be kept to a minimum with the hinges being as discreet as possible. To compete in this market, the retail price of the bicycle should be approximately £500.

## 6.2 Product Design Specification (PDS)

The product design specification builds on the Statement of Requirements and maps out all of the constraints and parameters that the final design must comply with. The PDS takes the most relevant headings as seen on the Design Core, (Appendix 6) and within each heading a list of the specific requirements is generated. The 15 most applicable headings were chosen and the following PDS was created.

1. Constraints
  1. Existing products will limit our design options (see 2.1)
  2. Bike must conform to existing transport regulations, ie max size for bringing on trains, buses etc (see 3.2)
  3. Folding size will be kept to a minimum so actual bike size will be limited
  4. Weight and max speed must be below the limit where it would become an electric motorbike
2. Patents/Standards
  1. Must not infringe on any existing patents and trademarks
3. Weight/Size
  1. Bike must be of a weight that can easily be moved/carried by a single person. Ideally below 10kg
  2. Size limited by transport regs
  3. Must not weigh more than an existing directly comparable bike
  4. Must be able to fold smaller than existing competitors
4. Customer
  1. Must be suitable for a wide range of ages
  2. Must be gender neutral as not to immediately exclude half of the potential market
5. Performance
  1. Must be capable of travelling at least 10 miles a day (average daily commute)
  2. Fold time must be as short as possible (if possible <30 seconds)
  3. Must be comparable in terms of rideability to direct competitors
  4. Must be geared appropriately for the expected terrain
  5. Brakes must bring bike to a stop in a safe distance
6. Aesthetics

1. Hinges must be kept discreet so that it is not immediately obvious is it a folding bike, but also so they do not impede the rider
  2. Colours will be gender neutral yet still aesthetically pleasing
7. Ergonomics
1. Riding position must feel natural as to not cause back pain during riding
  2. Riding position must be adjustable so all heights of rider can be accommodated (5'0" – 6'6")
  3. Must fold to a size and shape that is comfortable to carry/transport
8. Materials
1. Make use of lightweight, low density materials to keep weight down
  2. Must remain affordable so can't use materials that are very exotic and expensive
  3. Potential materials must have a low strain to failure ratio
  4. Stiffness is critical so chosen material must be stiff enough to handle all potential loads on it
9. Quality/Reliability
1. Prototype must be of a quality that allows it to be ridden at the competition
  2. Any electric components must be reliable so frequent breakdowns are not likely
  3. Components bought from the shelf will be expected to be of high enough quality as to perform as they should
10. Time Scale
1. There is a limited time for complete design and manufacture. Bike must be complete before deadline of 27<sup>th</sup> April 2015
  2. Exams and holidays will further reduce the time available to 24 weeks
11. Processes
1. Manufacturing processes will be limited due to lack of experience within the group and also lab technician availability
  2. Standard components will be used in areas that will be too difficult to manufacture in house
12. Product Cost
1. Project budget is limited to £100 per group member, so a total of £600 is available
  2. Extra funding can be applied for so this total will hopefully be increased, allowing a better bike to be built
13. Testing
1. Prototype must be built in time to allow for testing prior to the competition day
  2. Competition is scheduled to take place on 2<sup>nd</sup> May 2015, but this is subject to change
14. Safety
1. Final prototype must be safe enough to ride without risk of injury to the rider
  2. During manufacture, safety rules within the working environment must be adhered to
15. Feasibility
1. The final design must be realistically possible to manufacture in the facilities available

## 6.3 Concept Generation

With the PDS now complete, the next stage of Pugh's Design process was the concept generation. This was done by firstly sketching some ideas and then passing them through a series of controlled

convergence matrices (CCM). This allows for the best overall design to be found. Each CCM compares the concepts to a 'reference' concept. Figure 2 shows the key to each of the symbols used for comparing each of the concepts to the reference.

The initial concepts (Appendix 6) designed were inputted into a controlled convergence matrix (CCM), shown in appendix 7, to decide on 4 concepts to bring through to the next stage of development. This process was done another two times showing the reduction in concepts from four to one, this was done by relating the concepts to the PDS and the best concepts were chosen.

After the first CCM, the remaining concepts were adapted to include the improvements discussed in the previous stage. Using the same comparison techniques the developed concepts were compared in a new convergence matrix shown below. Concept 2 was used as a reference as it was one of the concepts at an average score from the previous CCM.

Concept:	1	2	7	8
Ride comfort	+	R	+	+
Folded Size	+	E	-	=
Ease of folding	--	F	--	-
Weight	-	E	--	-
Aesthetics	++	R	+	+
Ergonomics	=	E	+	+
Feasibility	-	N	+	++
Complex Components	-	C	+	++
Manufacture Price	+	E	+	++
Total +	5	////////	6	9
Total -	5	////////	5	2
Total =	1	////////	0	1
Net Score	0	////////	1	7

Figure 1 – Controlled Convergence Matrix 1

KEY	DEFINITION
++	Significant Advantage
+	Slight Advantage
=	Equal to reference
-	Slight Disadvantage
--	Significant Disadvantage

Figure 2 – CCM Key Legend

Following up on the convergence matrix a discussion took place as to the pros and cons of the concepts brought through. The discussion focussed on more practical sides of the concepts since a prototype will have to be constructed in a very short time scale. This meant a focus on complexity of components and price of components that are impossible to machine with the resources available through the laboratory. Therefore many parts of the concepts will have to be bought in due to the complexity of shape or the complexity of manufacture.

The initial concept to be ruled out was concept 1 due to the fact it incorporated single arm forks. These forks are a new design and are still very expensive. This meant being able to construct the bike would prove impossible on the budget available. Concept 2 was ruled out due to its complexity of parts and the difficulty of use. The two wheel steer mean users may be put off due to the increased complexity over a traditional bike.

This left two concepts, 7 and 8. These concepts are the closest to a traditional bike with enough innovation to be noticeably different to the majority of the market. They were brought forward to a

final design stage to decide which to pursue. Two more CCM's were made switching reference concept to show a complete picture of the pros and cons each.

Concept:	7	8
Ride comfort	R	=
Folded Size	E	+
Ease of folding	F	+
Weight	E	-
Aesthetics	R	-
Ergonomics	E	=
Feasibility	N	+
Complex Components	C	+
Manufacture Price	E	+
Total +	////////	5
Total -	////////	2
Total =	////////	2
Net Score	////////	3

Figure 3 – Final Controlled Convergence Matrix

Concept 8 was chosen due to its ability to dynamically fit different heights of the riders and its compact folding size using the innovative telescopic top tube but with what could be considered typical rear triangle and front forks.



## 7.0 The Final Design

The final design chosen is shown below in Figure 4. It combines various components of other concepts into a package that the group believes successfully fills a gap in the market and be a success at the CDIO competition. An electric assist front wheel will provide the power assistance while an innovative slide and fold mechanism will ensure the bicycle folds down to a compact size.

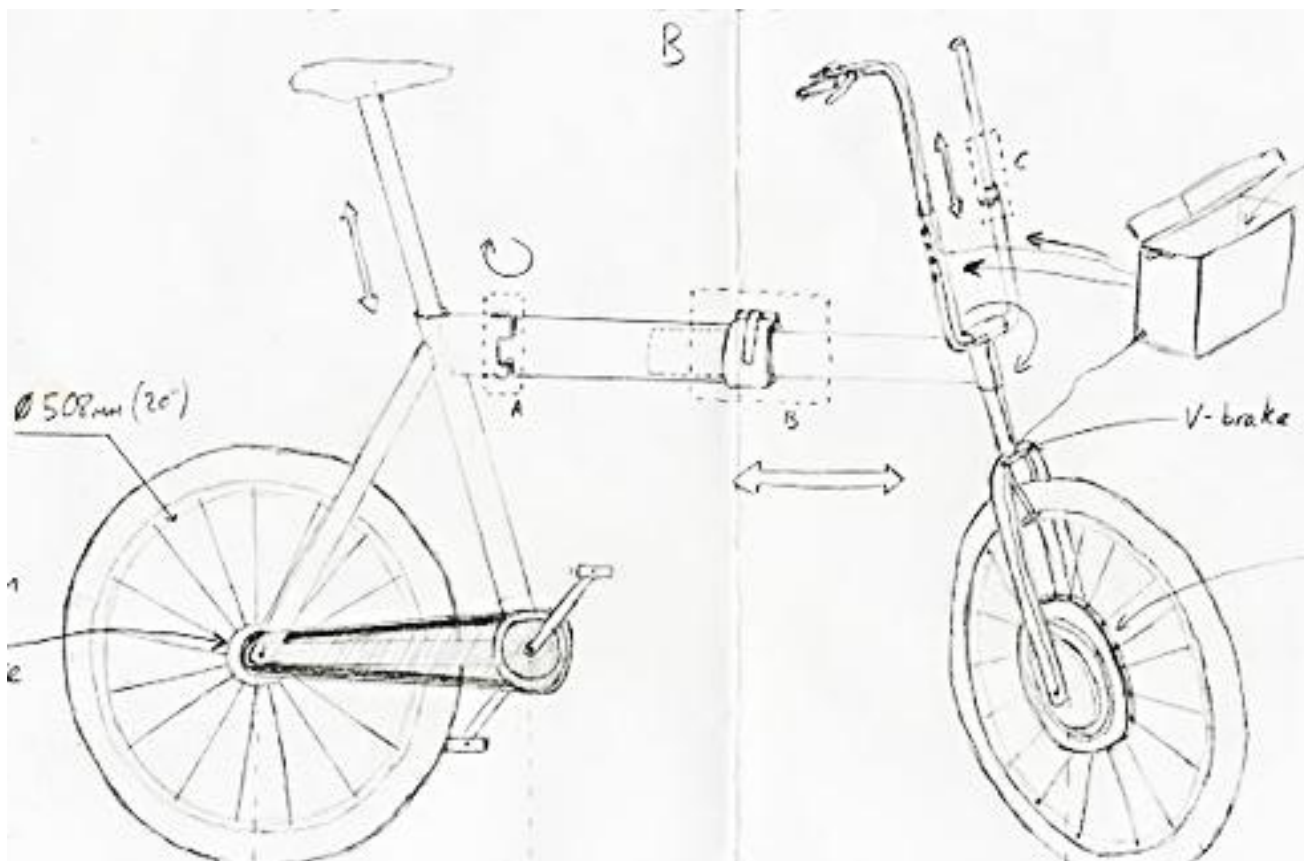

Figure 4 - Final Design

## 7.1 Material Investigation

For the purposes of the prototype, stainless steel was chosen since it has a relatively high strength-to-cost ratio and the project had to be completed within the limitations of an academic budget.

During the intermediate design phase, various materials were compared and researched based on their mechanical properties, cost formability and overall suitability for bicycle use from reviewing online literature. These materials were compared in the matrix below in Figure 5.

CRITERIA	MATERIALS						
	PEEK/IM carbon fibre	Trivex	Molybdenum, 360 grade	Titanium, alpha-beta alloy	AISI 4130	High strength low alloy steel	Aluminium
Weight (density)	+	+	-	-	-	-	R
Processing (energy use)	-	+	-	-	+	+	E
Disposal (recyclability)	-	0	-	-	+	0	F
Cost	-	-	-	-	+	+	E
Performance (overall strength)	+	+	+	+	+	+	R
Wear resistance	+	+	-	+	-	-	E
Shapability	-	?	-	-	+	+	C
TOTAL +	3	4	1	2	5	4	E
TOTAL -	4	1	6	5	2	2	////////////////
TOTAL 0	0	2	0	0	0	1	////////////////

Figure 5 – Material Investigation Matrix

While the prototype is made of stainless steel, a different material may be utilised at later stages in a commercial version of the bicycle. Ideally, a material such as Trivex would be used since it is high strength, lightweight polymeric material and thus can be injection moulded. Trivex was developed as military visual armour and has had mainstream adaptation in optics. It is a urethane-based polymer that is also very chemically resistant. Currently, Trivex is primarily used in aerospace applications and contact lenses (often presented as a comparable if not outperforming alternative to polycarbonate). Trivex can endure high internal stresses as for instance, unlike polycarbonate, it does not crack around drill holes (Femire, 2014).

A German consulting firm, Designaffairs, has actually created a traditional bicycle using Trivex and states that the properties of this “advanced polymer” are like those that “would only be expected on an old Italian steel frame.” While the actual cost per kg of Trivex does not seem to be available publicly, sources infer that it costs roughly twice as much as polycarbonate. However, the cost savings from mass manufacture are meant to make Trivex cheaper than other high performance materials (Clarity bike, 2014).

Comparing machine process energies involved for polycarbonate, AISI4130 versus a lay-up or autoclaved composite, at first, it seems that a polymer incurs relatively higher energies which may make it seem unfavourable at a first glance. (Refer to Figure 6). However, it must be considered that the additional machining and welding that must be done in order to finish and join the metal parts requires more energy and manufacturing time and also involves more personnel, increasing the overall manufacturing cost. An injection moulded frame may also provide more structural stability as welding creates heat affect zones at the joints and the welding material must be chosen with attention to the possibility of corrosion due to dissimilar metals in contact.

Polymer bicycles have been introduced to the market in the past but the general lack of structural integrity in previous models has discontinued their use. Innovation in polymers such as Trivex are promising advancements that may proliferate the use of polymers in more high strength applications so that machines and devices, such as bicycles, can be mass-produced at a lower cost.

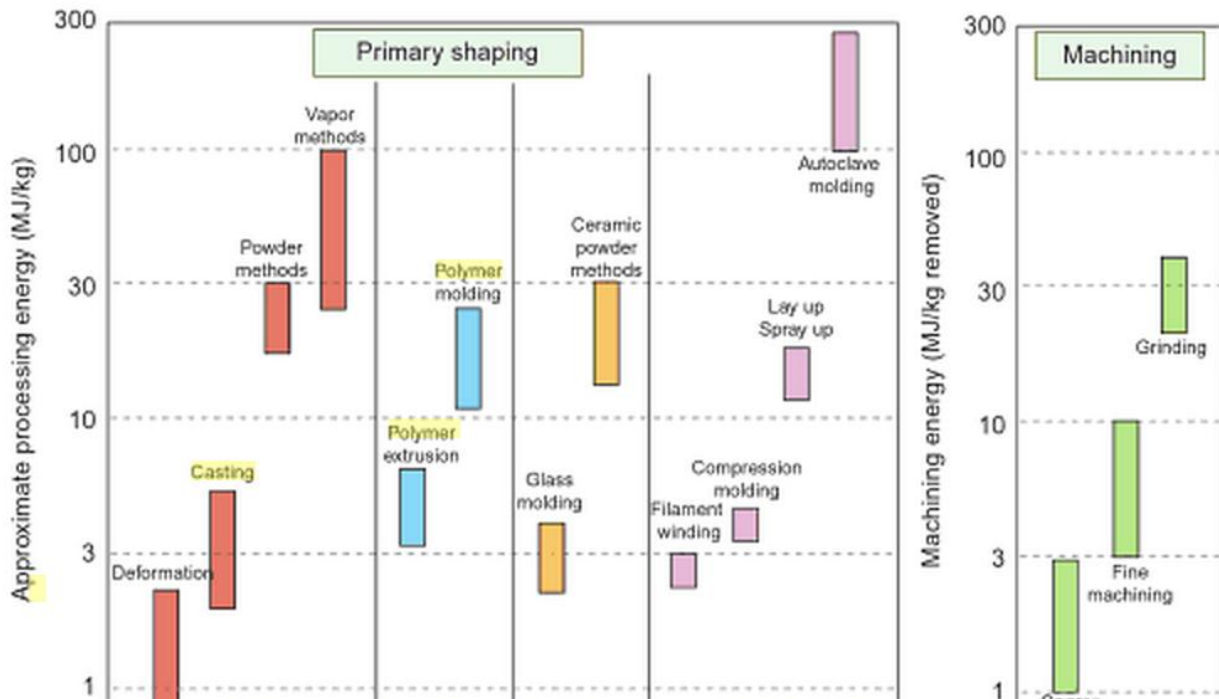

Figure 6 - Approximate processing energy of various manufacturing methods

## 7.2 Bending calculations

For the hand calculations of the deformation of the handlebars it is necessary to simplify the shape and to do it in 2D separating the horizontal force produced by the inertia of the mass of the commuter when braking and the vertical force produced by the weight of the person.

The first calculation made is the vertical displacement. At first it is necessary to know the values of the area of the hollow tube that is used. It is calculated by knowing the outer radio and the inner one and the value is:

$$A = \pi(ro^2 - ri^2) = 5.71 \cdot 10^{-5} m^2$$

After this calculation of the the Inertia momentum of a hollow circular tube has to be done which formula and result knowing the size of the tube are:

$$I = \frac{\pi}{64} (Do^4 - Di^4) = 0.6912 \cdot 10^{-8} m^4$$

For the calculations the Young Modulus is needed of the material of the tubes which in this case is steel and the value is the following one:

$$E = 207 \times 10^9 \text{ GPa}$$

Finally knowing all of this we can calculate the maximum deformation of the handlebars on the extreme where the vertical and horizontal forces are considered to be located. A diagram of the handlebars free body diagram is shown in appendix 8. The displacement produced by the force is divided into the effects produced by bending and the compression of the vertical bar of the handlebar although the compression is so small that could be considered as negligible.

$$\delta = \int \frac{M}{EI} \frac{\partial M}{\partial F} dl + \int \frac{N}{EA} \frac{\partial N}{\partial F} dl$$

$$M = F \cdot x_1 + F \cdot x_3$$

$$N = F$$

M: Bending momentum created by the external force

N: Compression force

$\delta$ : Total deformation

$$\delta = F \frac{x_1^3 + x_3^3}{EI} + F \frac{x_2}{EA}$$

Total force is split into vertical and horizontal. It has been assumed that the vertical force would be 70% of the total force and the value calculated was  $F=803.44\text{N}$

Then the final result for the vertical displacement is  $8.98 \cdot 10^{-3}\text{m}$  in the force direction.

Calculations of the horizontal displacement due to the inertia force are quite similar. In this case it is taken into account that the horizontal force creates a bending deformation on the top part of the handlebar, that force is transmitted to the vertical tube and transformed into torsion deformation. This middle bar transmits the deformation to the bottom tube producing another bending moment that means more total deformation so both bending deformations are summed in order to get the horizontal deformation. The values of lengths and the main formula is the same but in this case the only deformation considered is the bending one.

$$\delta = \int \frac{M}{EI} \frac{\partial M}{\partial F} dl$$

$$\delta = F \frac{x1^3 + x3^3}{EI}$$

The maximum value of the horizontal force considering that 70% of the total force is in that direction is  $748.57\text{N}$ . Finally the maximum horizontal displacement of the handlebars would be  $8.37 \cdot 10^{-3}\text{m}$

## 7.3 CAD

### 7.3.1 Solidworks

Initially the finalized design sketch was used to find dimensions of the parts of the bike to follow the aesthetics of the design, but also to include adequate dimensions to account for road height and design around components that are outsourced due to complexity such as bearing sets and drop outs. The dimensions of the tubing required were initially researched, to find what like for like bikes in the market used and what frame builders would recommend.



Figure 7- CAD model of front forks and handlebars



Figure 8- CAD model of middle section



Figure 9- CAD model of rear triangle

Initially the finalized design sketch was used to find dimensions of the parts of the bike to follow the aesthetics of the design, but also to include adequate dimensions to account for road height and design around components that are outsourced due to complexity such as bearing sets and drop

outs. The dimensions of the tubing required were initially researched, to find what like for like bikes in the market used and what frame builders would recommend.

Using the specific design drawing to develop individual parts, the design was undertaken in three separate stages the front end shown in figure 7, the top tube and folding mechanism in figure 8 and finally the rear triangle in figure 9

The front forks were designed with workshop availability and the skills of each group member in mind. For these reasons, they are a simple design which uses simple single bend forks with plate dropouts inserted and joined via brazing. The steerer and head tube were sized using standard sizes as these would be able to accommodate off-the-shelf headset components. This led onto the stem which is a simplified version of a readily available stock. The handle bars had to differ slightly from the original design due to the risk of a quick release stem collapsing over time and due to the high stresses presumed. The newly designed handle bars have clamps at the bottom of the vertical section represented by a simplified version of a quick release clamp to allow the bars to fold in and down when the bike is in its folded state.

The top tube had two major design considerations, the sliding portion towards the front of the top tube and also the hinge towards the rear. The sliding section will be secured by a quick release clamp which is represented by a simplified version of itself in the CAD models. This sliding section acts to reduce the overall length of the bike so that it can fold into a more compact shape. The hinge was designed to act in the same manner as existing folding bicycle hinges and also sized to fit in and not look too cumbersome compared to the top tubes.

Finally, the rear triangle was created. Like the front forks, these had to be designed with workshop availability and group member skills in mind. It was possible to design the seat stays with a simple single bend but the chain stays were more complex. This was due to the dimensions of the crank and rear gear dictating the overall shape of the stays since they need to be able to rotate unimpeded. The chain must also be able to move in a straight line between each sprocket without any unnecessary bending. The bottom bracket was designed using the British standard size of 39.8mm, the reason for this being that standard off-the-shelf parts are inserted and fixed into this component. The angle of the seat tube was calculated to be 73 degrees from the horizontal axis as this was an angle at which the ride comfort would be good and the rear seat did not sit too far back. With a rear seat too far back, there would be a degree of instability at the front end once the bicycle was fully extended due to the majority of the riders' weight being positioned too far rearwards. The seat tube length was set at 450mm as this would give an optimum range of seating height when combined with a standard 400mm seat post. The seat stays were then fitted to the seat post and rear drop outs at an angle in which the seat stay and the top tube joined the seat tube at the same point.

The final model was then completed using wheels, seat and seat post that were downloaded from 'GrabCAD', a freely available CAD sharing website. None of these were critical to the further modelling of the bicycle, they were purely included to show the 3D representation of the complete bike in its final form. This final design is shown below in Figure 10. Additionally, the technical engineering drawings of each component are included within Appendix 10.



Figure 10-Final CAD model of complete bicycle

### 7.3.2 ANSYS

Once the CAD model was finalised, an ANSYS static structural analysis was carried out. Workbench 15 was used to perform this.

#### 7.3.2.1 Mesh

The geometry was imported from Solidworks and a mesh was created. The mesh was of key importance to the ANSYS model as this influenced the accuracy and speed of the solution. Too few elements would lead to inaccurate results with too many elements resulting in long solver runs, increasing computational cost or exceeding the number of nodes available for the particular licence available. As the bicycle has a large geometry the distribution of elements was of upmost importance to allow a finer mesh in areas where stress and deformation were believed to occur.

The section of the bike that was believed to carry the maximum stress and where deformation would occur was along the middle tube. This section was of a completely different design to a standard bicycle as it did not have a supporting diagonal bar. In addition to this, the middle tube was to be constructed from two different sized tubes which could slide in and out and held in place by a quick release clamp. This section also had a hinge located approximately 200mm from the seat tube, which would allow the bicycle to fold. It was therefore believed that this part was of key importance due to the presence of the hinge and sliding mechanism and should have a highly refined mesh to allow for more accurate and precise results.

Under front braking, the front dropouts and forks would experience a high level of stress therefore the mesh around this area needed to be further refined. Similarly when the bicycle was experiencing back braking, the rear dropouts and back triangle would be required to withstand large forces and therefore needed a similar mesh to the front dropouts and forks.



Furthermore the areas of the bicycle that were to be welded together would experience large stress concentrations and needed to have a precise mesh.

As can be seen in figure 11 the mesh of the complete bike frame was quite dense and consisted of both quad and triangle elements.

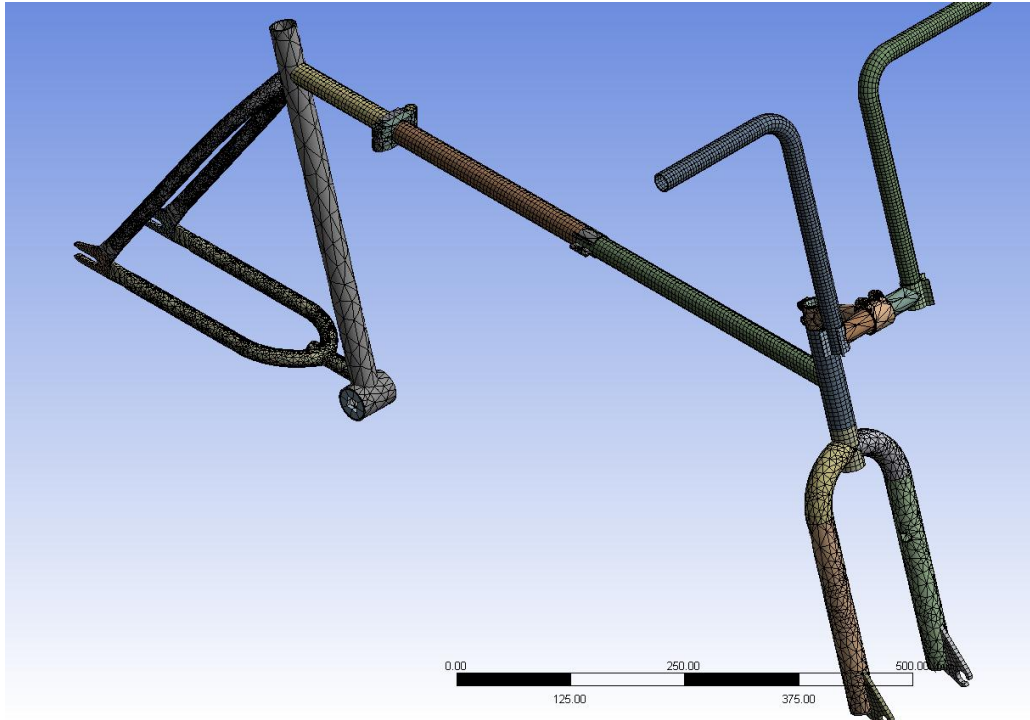

Figure 11 - Overall ANSYS mesh

As stated previously the front forks and back triangle were of key importance and therefore edge sizing were used to ensure there was a continuous mesh between the back triangle and rear dropouts and also the front forks and dropouts. This is illustrated in figures 12 and 13.

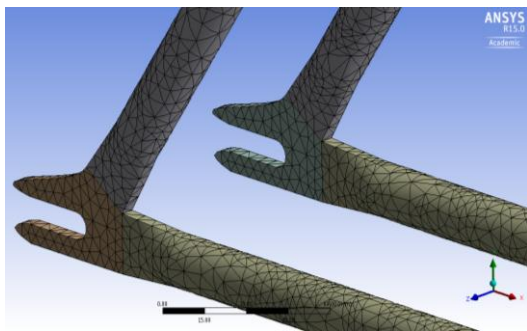

Figure 12 - Refined mesh around rear dropouts

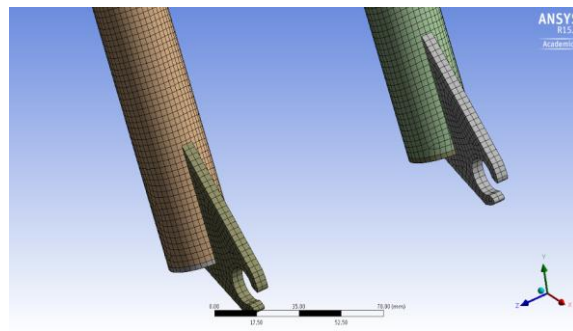

Figure 13 - Refined mesh around front dropouts

The hinge was a particularly difficult part to analyse due to the complexity of the mates needed to gain an accurate representation of a real life hinge. Due to the time scale, a simple representation of this was designed. First, the hinge plate end was bonded to a pin located between the two plates, and then this pin was bonded to the front plate of the hinge to allow movement in the hinge. The

mesh created was even further refined due to the importance of this part. Edge sizing was used to ensure the mesh between the hinge and the middle tubes had a smooth transition.

### 7.3.2.3 Setup

It was believed that the maximum stress and deformation of the bicycle would occur when it was placed under full front braking and full rear braking. To achieve these conditions, the rear dropouts were seen as a fixed support and the front dropout free to move in the X-axis but restrained in the Y and Z axes for rear braking and for front braking the opposite was true (front dropouts fixed and rear dropouts free in the X-axis).

The distribution of weight of the rider had major implications on the distribution of the forces throughout the bicycle. The worst case scenarios were considered as this is where maximum stress and deformation would arise. A 70%/30% weight distribution between the handlebars and the pedals for front braking and a 30%/70% between the handlebars and pedals for rear braking was analysed. A distribution of 30% for the pedals, 20% for the seat and 50% for the handlebars was similarly investigated for front braking and 50% pedals, 20% seat and 30% handlebars for rear braking. In order to apply these forces, the 'force' section within the 'loads' pane was selected for the handlebars and the seat and a bearing load was used for the pedals.

As the force applied to the bicycle was the force needed to bring the bicycle to a complete stop without sliding from an average speed of 15 m/s, the forces in the X and Y directions were calculated to include this deceleration rate.

In order to calculate the maximum deceleration from 15m/s, the stopping distance was needed. This was found using equation 1;

$$s = \frac{v^2}{20(f+f_r)} \quad \text{(Equation 1)}$$

Where v is the velocity, f the static friction and  $f_r$  is the rolling friction. From this the deceleration of the bicycle was calculated using equation 2.

$$a = -\left(\frac{v^2}{2s}\right) \quad \text{(Equation 2)}$$

Using a maximum human mass of 102kg with the maximum bicycle mass of approximately 15kg, a rolling friction of 0.014 and static friction of 0.9, the stopping distance was 12.31m and the deceleration was 9.14m/s<sup>2</sup> (Wilson, 2004).

Table 1 shows the total weight in the x and y direction and how this is distributed across the bike. The total force in the y direction is the total mass (rider and bike) times by gravity (9.81m/s) with the total force in the x direction being the total mass multiply by the deceleration. The results of these calculations are shown below in Table 1.

Forces (N)	Weight(N)	70%	50%	30%	20%
<b>Y direction</b>	1147.77	803.439	573.885	344.331	229.554
<b>X direction</b>	1069.38	748.566	534.69	320.814	213.876

Table 1 – Deceleration forces present

### 7.3.2.4 Results

Once the simulation was complete, the maximum stress and displacement could be easily seen. It was clear from the first simulation that the thickness and diameter of the tubing was too large as there was little deformation or stress. It was therefore decided to optimise the CAD model to allow for smaller size tubing. This would have the added benefit of reducing the overall weight of the bicycle

#### Front Braking

The distribution of force, 70% at the handle bars and 30% at the pedals demonstrates how the weight is allocated through the bicycle during standing front braking. As illustrated in Figure 14 a, b and c, the maximum stress was 1738MPa and located between the head tube and stem. The stress throughout the remaining bicycle was relatively low at less than 150MPa. There was a maximum displacement of 14.8 mm at the handlebars.

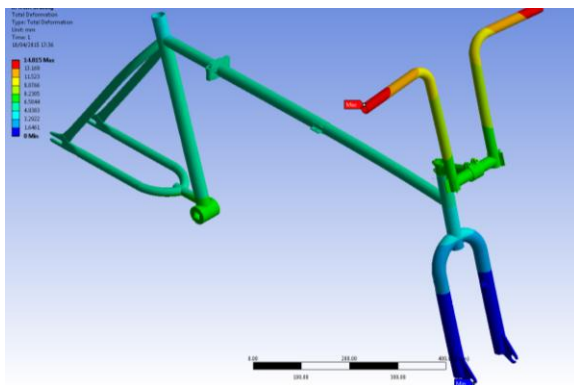

Figure 14a - Maximum Deformation Plot, standing front braking

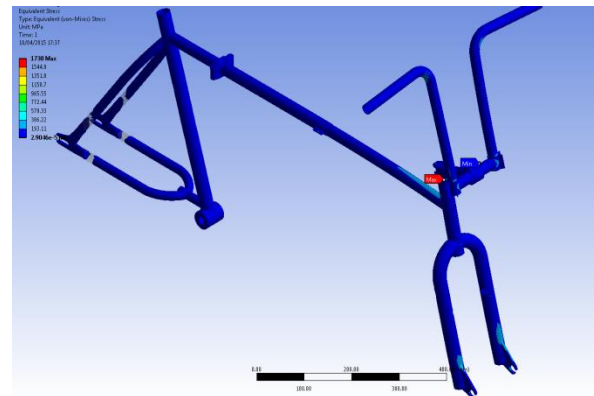

Figure 14b - Maximum Stress Plot, standing front braking

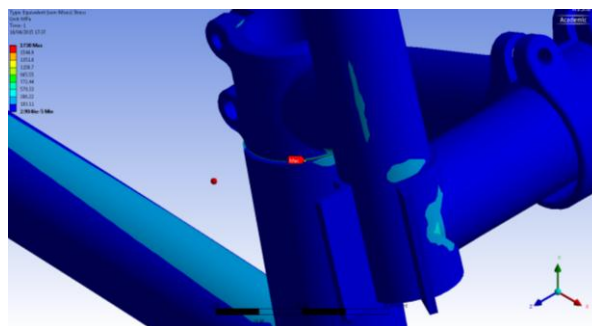

Figure 14c - Zoom view of Max Stress Plot, standing front braking

When the rider is seated it was assumed that 50% of the force would be located in the handlebars and the remaining weight would be distributed between the pedals (30%) and the seat (20%) for front braking. Similar to the results gained for standing front braking, the maximum displacement was 12mm at the handlebars and a maximum stress of 1477MPa located at the steerer. These results are shown in Figure 15a, b, c.

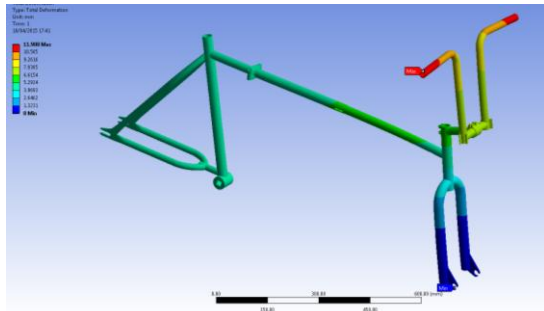

Figure 15a - Maximum Deformation Plot, seated front braking

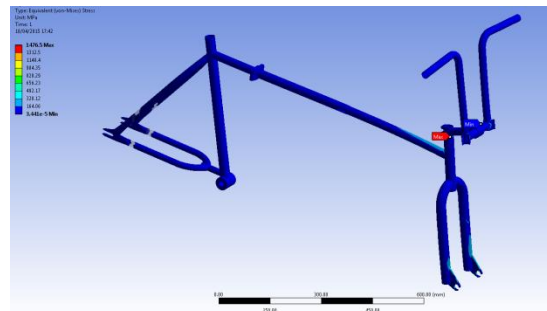

Figure 15b - Maximum Stress Plot, seated front braking

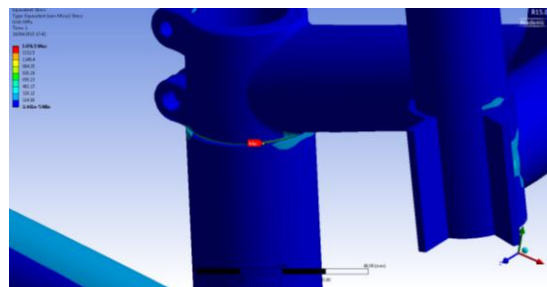

Figure 15c - Zoom view of Max Stress Plot, seated front braking

### Rear Braking

When the bicycle is under rear braking, it was assumed that the weight would be divided as 70% to the pedals and 30% on the handlebars when the rider is standing. This would change when the rider is seated to 50% on the pedals, 30% at the handlebars and 20% on the seat.

Figure 16 a, b and c show the stress distributions and maximum displacement during standing rear braking. The maximum stress was 426MPa and was located at the junction between the seat post and the seat stay. The maximum displacement of 8.8mm was located at the handlebars and also through the hinge.

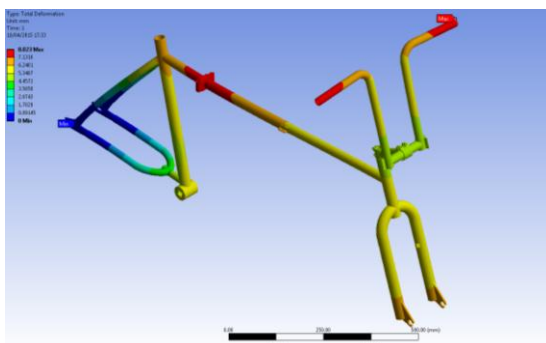

Figure 16a - Maximum Deformation Plot, standing rear braking

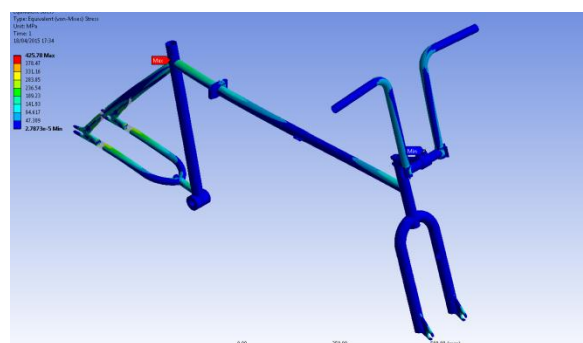

Figure 16b - Maximum Stress Plot, standing rear braking

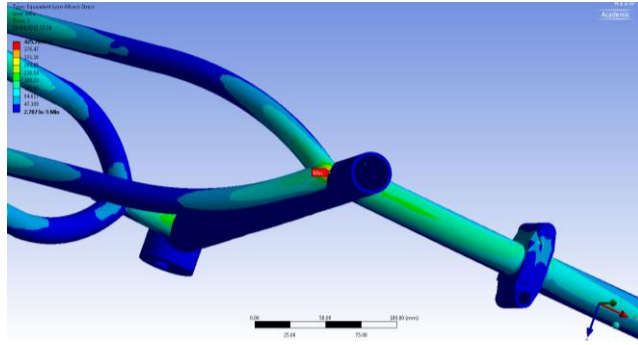

Figure 16c - Zoom View of Max Deformation Plot, standing rear braking

For the seated rear braking with the weight distribution as described above, the maximum stress is 489MPa located at the join between the seat post and the seat stay with a maximum deformation of 8.7mm located at the handle bars and also the middle tube through the hinge similar to the standing rear braking. Again, these results are shown in Figures 17 a, b, c.

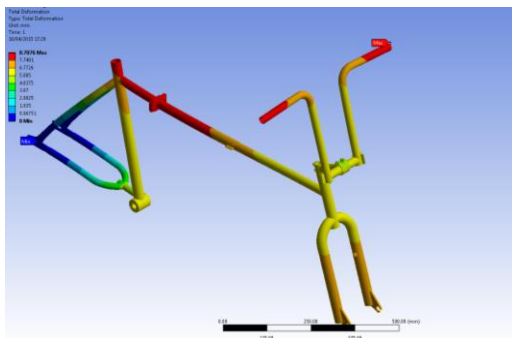

Figure 17a - Maximum Deformation Plot, seated rear braking

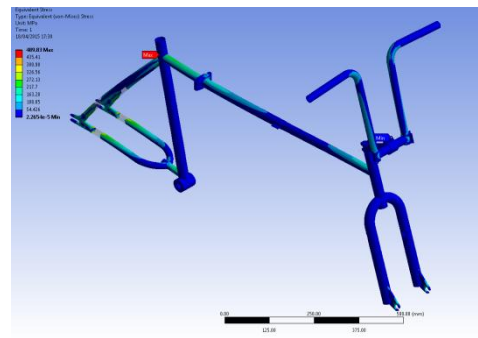

Figure 17b - Maximum Stress Plot, seated rear braking

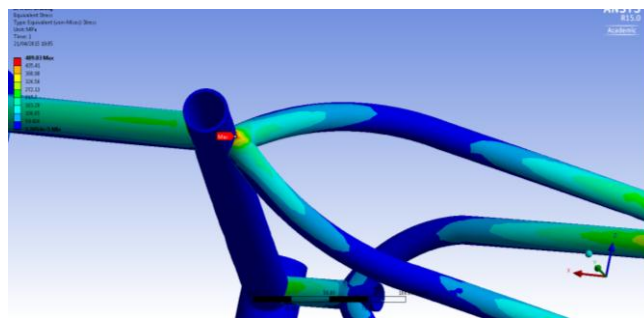

Figure 17c- Zoom View of Max Deformation Plot, seated rear braking

### 7.3.2.5 Discussion

As illustrated by the simulations, the maximum displacement was approximately 15mm located at the handlebars due to the forces pushing in the positive x direction but also causing them to rotate towards the ground. As the deformation is relatively small, it was believed that the effects of this would not be felt or noticed by the rider and therefore provided reasonable stiffness for the bicycle frame.

There was also approximately an 8mm displacement located in the middle bar and through the hinge. This once again is relatively small and was assumed that this would not affect the ride comfort and was therefore assumed acceptable.

A safety factor of 2/3 of yield stress was used to gain the maximum allowable stress for the stainless steel in which the prototype is to be constructed. The maximum stress was seen during rear braking and had a value of approximately 490MPa. It was therefore concluded that the maximum yield stress for the steel used in manufacture should be no less than 500MPa. This would provide a large enough yield stress to allow the frame to safely support a rider of a maximum weight of 102kg.

However under front braking there was a yield stress of approximately 1700MPa located at the stem. As this part was to be purchased from an established company, it was believed that the part would not actually be under this high stress and would also have a higher yield value than of the steel used in manufacture. This stress was also located in the bearings which were not modelled in this ANSYS simulation.

The ANSYS simulation gave a rough representation of how the structure of the bicycle would fare under front and rear braking and as the results give sufficient evidence that the bicycle would be structurally sound, the construction/build phase could begin. The ANSYS results were used in the ordering of material and standard parts. There would be further testing carried out throughout the building phase to support the ANSYS results.

## 8.0 Funding

Once the design of the bicycle was complete an estimation of the cost of the project was conducted. This was necessary to predict any shortfalls in funding and to plan for how best to avoid these. Each student in the group was assigned a budget of £100, giving a total for team J of £600. As discussed in section 6.1, the design intent for the bicycle was to create a folding electric bicycle which could be sold at market for approximately £500. To clarify, this is the target price that the bicycle would be sold at if it were to be mass produced for the retail market. As with any fully functional prototype, the manufacture and development of the ZoomBYke prototype would cost significantly more than the final product if and when it were to be manufactured for market. In addition to this, the group were very aware of the fact that one main aim of the project was to compete in a competition with other British universities in which the bicycle would be judged on various aspects of its design and performance. The cost of travelling to the competition at Queen's University in Belfast had to be considered in the costs of the project and on top of this it was the desire of the group to manufacture the best possible version of the design to be as competitive as possible on the day of competition.

For these reasons the cost estimation was completed in two stages; firstly an estimation was made of the cost of the project including manufacture of the best possible version of the group's design with a top specification to allow maximum competitiveness; then an assessment of how best to use the funds provided if no additional funding could be secured i.e. the project budget would be limited to £600.

Appendix 9 shows cost predictions for the project and it can be seen that to build the top specification prototype and attend the competition the group would require approximately £1725.

This estimation was based on extensive research into components and suggested that if the group were to build the bicycle to the desired standard it would be necessary to source additional funding of approximately £1725. The alternative, if it was not possible to secure this money, was to build a simplified prototype. The cost prediction for the simplified prototype and travel to the competition was £790 which was still greater than the funds available but if the extra funding was not available the group had discussed methods of lowering this cost such as adding personal money to part-fund the travel to Belfast.

Fortunately the following additional funding was kindly provided.

- University of Strathclyde Department of Mechanical and Aerospace :
  - Provided £1000 additional funding
  - Originally provided as £600 for prototype build and £400 for travel to competition but freedom to re-arrange to suit project needs was given by Professor Mackenzie.
  
- University of Strathclyde Faculty of Engineering:
  - Covered cost of travel to competition

The funds were provided due to the fact that the team will be representing the University, the Faculty and the Department at the competition and because of the detailed costing plan which validated the amount of funding being requested.

The appended document also details how much each item originally estimated actually cost and it can be seen that the project was brought in under budget. The remaining funds will simply remain in the Faculty and Departments' accounts.

## 9.0 Business Case Plan

From the consumer survey conducted during initial scoping for the bicycle design and market research, two markets emerged as primary target markets: a) young adult commuters who take various modes of transportation to work/school, aged 18-30; and b) commuters in developing economies where bicycles the main mode of transportation. The test market will likely be based in the UK as it is the origin of the ZoomBYke's development and with large investments to come in British cycling infrastructure, the use of bicycles for commuting transport is expected to become more common. "Hype" for the product would likely be generated online using similar marketing techniques as other start-ups such as OnePlus.

Effectively, phase zero of the product cycle has been completed with the prototype as it encompasses the design and functionality of the folding bicycle itself. The first phase of introducing the ZoomBYke to the market will be a validation phase that involves setting up a small workshop and storage facility. In terms of availability and ease of manufacture, the first edition of the ZoomBYke may be more feasibly manufactured with a CrMo alloy steel such as AISI4130 mentioned earlier since the upfront cost of creating moulds or purchasing an injection moulding machine would likely be too much liability to take on. Compared to other materials, AISI4130 costs significantly less than other alternatives that perform better but still costs significantly more compared to stainless steel - especially, for high quality grades of CrMo. However, these first edition ZoomBYkes would be sold at low to nil profits, existing mainly to generate awareness of the product. Production costs would be

significantly lower than the those involved for the prototype as manufacturing could be outsourced for cheaper labour and material (transport costs would be mitigated). As well, the electric motor which is a major portion of the expense could also be purchased for cheaper in bulk and from a more inexpensive Chinese manufacturer. (One of the main underlying reasons why a British motor was used for the prototype was availability during our timeframe since shipping times from China were extremely long).

Crowd-funding at this stage would likely be a significant source of venture capital, but government schemes are another potential source as the ZoomBYke is aligned with agendas towards promoting sustainable transport. If this initial “introduction” phase is successful in generating support from the limited set of users and public interest within a period of a few years (2-3), then further investment will be made into the project to produce the ultimate design concept. These years will likely have costs on the scales of > 100,000 GBP considering the following expenses:

Workshop space

Material costs

Electric motor costs

Personnel (skilled and unskilled trainable workers)

Shipping costs

Online presence

Time cost of simulating injection moulding manufacturing

The subsequent phase of ZoomBYke production with a polymer will require a higher start-up cost as the injection moulding equipment itself will cost upwards of 60 000 USD (40 200 GBP) since a multi-cavity mould will be required for the different components of the bicycle (Injection Molding, 2015). While the material and energy costs will be lower than those required for a metal bicycle, the start-up cost is undeniably high but a previously confirmed vested external interest would validate large-scale production. The funds for this phase will likely mostly come from potential venture capitalists and crowd-funding.

In the initial design brief it was decided to produce a folding electric bicycle which would retail for approximately £500. Calculations have shown that this could be satisfied if a polymer frame is employed however the first batch of bicycles would have a low profit margin to satisfy this requirement. To retail at £500 it is assumed that the sale price from the company to the retailer would be approximately £250 for a large order. This is a 100% profit margin for the retailer which is relatively high for bicycle sales but for the sake of this analysis provides a worst case scenario in terms of profit for ZoomBYke and would give retailers a good incentive to buy and promote ZoomBYke. The overall cost of the bicycle itself is estimated at 187.5 GBP for the first 1000 bicycles considering the skilled personnel needed at hand to manage the injection moulding equipment and to cover the costs for this new equipment. This leaves our company with a profit of £62.50 per bicycle or 33.3%. By and far, this is a major improvement on the prototype - a 90% reduction in cost.



Over time (a projected 5 years), as the company grows, injection moulding machines would be repaid through profits through more sales and the company could operate at a higher profit margin.

<i>Costs in GBP</i>	<b>Prototype (stainless steel)</b>	<b>Mass produced polymer (first 1000 bicycles cost)</b>
<b>Material and motor cost</b>	1260	11.22 (material) 50 (electric motor)
<b>Manufacturing cost</b>	603 based on 90 hours of labour at UK minimum wage (6.70/h)	12.53
<b>Total cost</b>	1863	187.5

Figure 18- Table of manufacturing cost

## 10.0 Website

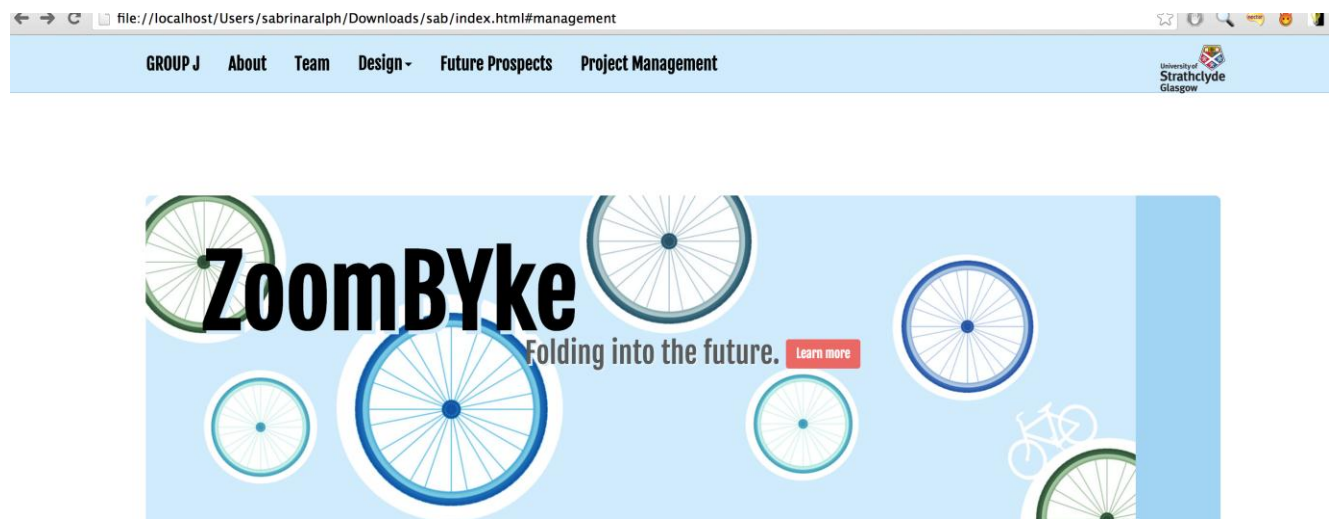

Figure 19-Front page of website

The website was coded using HTML5, Javascript and CSS and also implemented Bootstrap framework. Bootstrap is currently the most popular framework for web development which is why it was chosen to give the website sleek, streamlined look. In the real world, appearances do make an impression, especially when trying to gain attention from potential investors. The blue and green colour scheme was chosen to emanate themes of clean transport and sustainability.

The website serves as a brief showcase of what the project involved, the team members, group dynamic, visual representations of the design phases and future prospects for the design.

## 11.0 Purchasing

Due to the bespoke nature of the bicycle, sourcing material for the manufacture of a prototype was a relatively complicated process. The purchasing was also not possible until the group received confirmation of whether additional funding would be available as this would influence which materials were bought.

Once confirmation was received that the group would receive additional funding it became apparent that the finances available would cover building the bicycle to the top specification. This involved using higher strength, specialist bicycle frame steel tubes. These tubes are thin and butted (see figure 20) so that the weight of the frame can be made as low as possible.

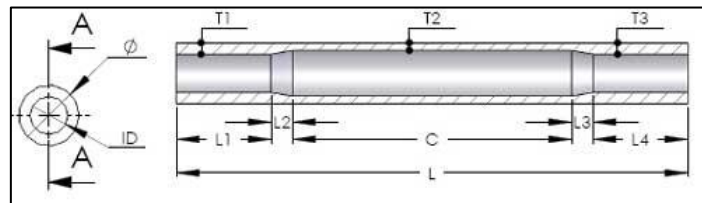

Figure 20- Double butted tubing

The extra funding also meant that pre-fabricated fixtures and lugs could be ordered which would ultimately make manufacture easier and less time-consuming. These included:

- Fork crowns: Cast stainless steel crowns into which fork blades could be brazed or welded
- Bottom bracket shell: Cast steel. Included two 22mm holes into which chainstays would be joined
- Front and rear dropouts: Cast steel dropouts with fixing points onto which chainstays/seatstays/fork blades could be brazed/welded
- Stem: Pre-fabricated steel fixture joining steerer to handlebars

The ANSYS analysis had given a good indication of how the bicycle would respond in terms of stress concentration when loaded in various ways. To ensure the bicycle would not fail all tubes purchased for the frame was larger than in the ANSYS analysis.

Originally it was planned to order high strength stainless steel tubes for the whole bicycle. This would ensure a high strength frame which would be easily TIG welded together. However, due to lack of availability of high strength stainless steel chainstays and seatstays these had to be ordered in Heat Treated Chrome-Moly Steel, which has a similar Ultimate Tensile Strength (1080-1280MPa) to the high strength stainless steel (1000-1200MPa). The use of dis-similar materials in the rear triangle meant that joints had to be brazed rather than TIG welded which was not a problem as this is a very common joining method used by custom bicycle builders. It was ensured that areas that had proven to contain high stress concentrations under ANSYS analysis, such as the top tube, were manufactured from the highest strength stainless steel and the joints between all stainless tubes were TIG welded.

Some of the frame components proved to be more expensive than predicted in the original cost estimation but to make up for this other components were bought for less than predicted. A good example of this is the rear wheel with Sturmey Archer 3 speed coaster hub. These wheels fully assembled are usually well over £100 new and unassembled (i.e. buy the wheel and the hub, then

assemble) are normally around £100. The rear wheel for this bicycle was taken from a Raleigh Chopper and refurbished by a bicycle specialist in England and bought for the project for £31.58 including postage.

## 12.0 Manufacture

All engineering drawings are included in appendix 10. The bike was manufactured in the three sections that it was designed in, the rear triangle, the top tube and the front end. The shape of the bike was slightly different to the CAD design due to the availability of materials and technical staff. As stated in section 11, the materials were purchased from specialist custom bicycle frame suppliers.

### 12.1 Rear Triangle

#### Tubing sizes

Seat Stays: 22mm OD. 0.7mm wt. 430mm L

Chain Stays: 22mm OD. 0.7mm wt. 370mm L

Seat tube: 31.7mm OD, 0.7/0.6mm (butted) wt. 450mm L

The first part that was manufactured was the rear triangle. The first stage of building this complex shape was to crimp the chain stays and seat stays to the rear dropouts at the desired angle. The other ends of each of the stays were then prepared for welding to the seat tube. The seat tube consisted of a straight tube inserted into a bottom bracket lug. Once all seven parts were ready they were clamped into place and then the technicians brazed the structure together. The rear part of the top tube was also brazed on at this point as reheating the seat tube again would have caused the previously brazed tubes to move out of position. Time restrictions in the lab meant that the stays were attached on to the side of the seat tube rather than being bent as per the CAD design.

### 12.2 Front Forks and Handlebars

#### Tubing sizes

Fork Blades: 28mm OD. 1.9mm wt. 230mm L

Steerer: 28.6mm OD. 1mm wt. 220mm L

Handlebar cross tube: 27mm OD. 1mm wt. 280mm L

Handlebar vertical tubes: 22mm ID. 1mm wt. 500mm L

Whilst the rear triangle was being brazed, the front forks were set up to be joined. The fork blades were left unbent as a fork crown had been purchased. They did however have to be cut down to size and, following this, the front drop outs were set in place. The steerer tube was also cut to size; however this was changed slightly from the CAD design due to the size of the stem that had been purchased. With all of the parts read, they were sent to the welding lab to be brazed together. The steerer was joined to the fork crown first as this heated the crown to a temperature where it could be stretched slightly to allow the blades to be fitted. Once the dropouts had been brazed it became

clear that the distance between the dropouts was too small to fit the electric wheel in. However this was solved by heating the forks and bending them outwards slightly.

The handlebars consisted of three parts, a main horizontal section that passes through the stem and also the two sections that the rider grips that then fold down when the bike is folded. The horizontal section was cut to size before having two vertical holes cut through to allow for the other handlebar sections to fit. Quick release clamps were welded above these holes to allow the other sections to be held securely in place.

The other two sections were made by cutting a straight tube to the desired length and then using a cold forming process to bend it to 90° to create the portion where the rider grips the handlebars and also where the gear shifter and brake levers are mounted. This process was repeated to create two identical components

## 12.3 Top Tube

### Tube sizes

Head Tube: 36mm OD. 1.1mm wt. 85mm L

Front Tube: 31.7mm OD 0.6/0.925 wt. (butted) 300mm L

Middle Tube: 34.9mm OD. 0.6/0.9mm wt (butted) 300mm L

Rear Tube: 34.9mm OD, 0.9/0.6mm wt (butted) 200mm L

The final part to be constructed was the top tube and hinge assembly. The first stage was to cut all of the tubes to the correct size and once this was done, the head tube was TIG welded to the front portion of the top tube. TIG welding was used in this instance as this is an area of high load concentration and also TIG lends itself well to joining two stainless steel parts. Again due to time and technician limitations, the hinge could not be machined as originally intended. Instead, a standard hinge was purchased and then modified before being TIG welded to the middle and rear portions of the top tube.

With all of the major structural manufacturing complete, the structural stability of the bicycle could be tested. At this stage the bike consisted of just the bare frame and wheels, all other components such as tyres, pedals etc. would be added at a later stage. This testing consisted of clamping the bicycle in place and applying a known load in various directions. Once the frame was deemed satisfactory, it was first painted and then all of the other components were mounted. Firstly, the bottom bracket was attached and the crank/chain were lined up with the rear chain gear and then bolted in place. The battery pack was then mounted to the seat tube and wired up to the wheel motor and controls. A purchased seat and seat post were then added and finally, tyres were mounted on to the wheels.

## 12.4 Finished Prototype

Appendix 12 contains photographs of the finished prototype on the way to empirical testing. The bicycle was gripped by both wheels while an array of loads were set on the load bearing parts. This testing showed results of negligible bending in the main frame with minimal bending in the handlebars. These results were done with the quick release clamps and the hinge tightened up

extremely well, with reduction in clamping force the frame starts to sag. This testing was concluded as a positive result so that the bicycle could be ridden with confidence that no problems would arise.

Over the course of manufacture issues arose in all parts of assembly. These were swiftly overcome through the competence of the team along with professional advice. The main issue was the lack of time due to late start of the build. This time constraint was overcome by the use of purchased lugs and hinge to enable swifter assembly. Other problems encountered were deformation due to heat under the welding process in the seat tube and head tube. These were overcome by turning inserts in the lathe.

The team are happy with the final prototype, however to some sourcing of correct materials the bicycle could be lighter. This problem could be overcome in mass manufacture sourcing direct from steel works.

## 13.0 Competition

The competition is being held on the 2<sup>nd</sup> of May 2015 in the Queen's University, Belfast, Northern Ireland as part of the regional CDIO challenge where each team were tasked to design and build a folding bicycle for the urban commuter which would be suitable for a commute which included the use of trains and buses.

As stated in the section 6, the bicycle was to be designed to be as light as possible and have the folded dimensions of no greater than 0.2 m<sup>2</sup> as this was in conjunction with the regulations of most public transport services. It was concluded that 20" wheels were the preferred option and that an electric assisted pedal bicycle would fill a gap in the already crowded market (section 5).

The competition would be used to assess the design of the bicycle by having each team to complete a number of tasks which simulated the standard commute for a folding bicycle. These guidelines were as follows;

1. Acceleration from a standing start
2. Timed circuit of several hundred metres
3. Slalom between cones
4. Time to unfold, travel a short distance and refold

The mass of the bicycle and the folded envelope (3 orthogonal axes) would also be significant in the ranking of the competition.

As a team we believe that our innovative design will perform well due to its light weight frame and quick folding/unfolding time. The bicycle is expected to be folded in under 30 seconds as there is only one hinged joint and 4 quick release clamps. The electrical front wheel, will also be an advantage for the timed circuits and acceleration, however it will also be of great benefit for the commuter when being used in real life situations (traffic lights, hill climbs).

## 14.0 Conclusions

### 14.1 The Group Dynamic

As mentioned before in section 4.0, there was no specific group leader during semester one and the start of semester two. However, as semester two progressed and we started to fall behind the project schedule we realised that a major change in group dynamic was needed. Due to the change in dynamic and creation of subteams the project ran more efficiently and managed to gain back time lost in the earlier weeks of the year. Once the group members had specific roles, the project moved forward with a lot more speed and efficiency.

The business sub team worked effectively on their tasks and completed the work on schedule with little issue. The coordination team kept the group on task with regular meetings and wrote the report in parallel with the work being done and added to the website to convey the progress of the bicycle. The technical team completed the analysis on time and finalised a model for manufacture. Enduring severe time restrictions the manufacturing team, along with the technical staff in the laboratories built the bicycle with minimal changes to the model received from the software team.

Reflecting back on the project as a whole, the entire group feels that they have worked well together, both before and after the change in group structure. Lack of serious conflict between group members has allowed the project to run smoothly as a whole. However, one major stumbling block encountered was people's timetables. Everyone in the group had a different timetable and this sometimes made it very difficult to organise meetings or set aside large portions of time for the whole group to work together.

### 14.2 The Project

Looking back at semester one, the management side of the project went very well and everything that was timetabled was completed on time. However, semester two didn't go as smoothly. In hindsight, too much was timetabled for semester two and a portion of this could easily have been done in semester one. Leaving the entire CAD design of the bicycle until after Christmas was not ideal and should have been started during semester one. Also, the amount of other work that people would have in semester two was not taken into consideration and workloads quickly increased up to a point where the project had to take a back seat. This was the main catalyst for the major change in group dynamic as stated in the previous section. With the project falling behind as it was, the contingency time had to be used. This was already within the main project plan and therefore still allowed for the bicycle to be completed in time for the competition.

This project was a design and build, so in theory perfectly suited to Mechanical Engineers. However, the scope of the project included aspects that could have suited a more interdisciplinary group. The electrical assistance system could have been designed from scratch by EME students rather than having to outsource it at a significant cost. Also, creating a business case plan and handling the financial side of the project would be ideally suited to students from the business school.

Looking now at the bicycle itself, the group feels that it has successfully filled the gap in the market that was spotted during the market research phase. If it were to be brought to the mass market, costs could be brought down to a more realistic level with the implementation of mass production

and also by limiting the amount of expensive outsourcing that was required for the prototype manufacture as stated in section 9.0.

### 14.3 The Project Management

At the end of semester one, the group felt that Gantt chart was followed very well as all major milestones that were timetabled were met and completed on time. However, it was felt that if the chosen design had have been of greater detail then the progress in semester two would have ran more smoothly. The dimensions for each part should have been finalised and in addition to this, research into where outsourced products would be purchased from should have been carried out. Due to the time restrictions faced at the end of semester two, the CAD modelling should have been timetabled to start after the completion of the interim report (middle of December) instead of at the beginning of semester two.

The group was slow to start after Christmas and January exams once again due to differing timetables at the beginning of semester two. The project didn't really begin fully again until week 3 of semester two when there was a change in the group dynamic as discussed in section 14.1. This had a knock on effect with the beginning of related tasks. As the CAD modelling didn't start until the beginning of February, approximately two weeks later than planned, the sections of the project that were dependant on this also fell behind. There were major problems with the ANSYS model due to the lack of experience within the group meaning a delay in the ordering of parts for manufacture. The manufacturing of the bicycle was a little rushed however was completed to as high of a standard as possible. The contingency time allowed for this time to be made back and allowed the bicycle to be completed on time. The lack of information on the competition from Queens University also led to a delay in the process of the project.

### 14.0 References

*Dahon Reports Steady First Half Growth.* (2009, 08 19). Retrieved 10 2015, from Bicycle Retailer and industry news: <http://www.bicycleretailer.com/north-america/2009/08/19/dahon-reports-steady-first-half-growth#.VHzirmSsXNU%22>

*Bikes on public transport.* (2014). Retrieved 11 2014, from Transport for London: <http://www.tfl.gov.uk/modes/cycling/cycling-in-london/bikes-on-public-transport>

*Clarity bike.* (2014). Retrieved 2 2015, from design affairs studio: <http://studioblog.designaffairs.com/clarity-bike/>

*Injection Molding.* (2015). Retrieved 3 2015, from Rex Plastic Inc: <http://www.rexplastics.com/faq.php>

Carey, J. (2006). *A Commuter's Secret Weapon.* Retrieved 10 2014, from Bloomberg Businessweek: <http://www.businessweek.com/stories/2006-06-11/a-commuters-secret-weapon%22>

Femire, B. (2014). *Trivex.* Retrieved 2 2015, from UCCS: [http://www.uccs.edu/~rtirado/PES\\_1600\\_SolarEnergy/trivex\\_lens.pdf](http://www.uccs.edu/~rtirado/PES_1600_SolarEnergy/trivex_lens.pdf)

Government, U. (2014, 11). *Electric bikes: the rules*. Retrieved 11 2014, from GOV.UK:  
<https://www.gov.uk/electric-bike-rules>

Politics, B. N. (2014). *Cycling investment should increase five-fold*. Retrieved 10 2014, from BBC New  
Politics: <http://www.bbc.co.uk/news/uk-politics-28352678>

Van Shaik, J. (2013). *Dahon Sales Conference in Positive Mood Again*. Retrieved 10 2015, from Reed  
Business Media: <http://www.bike-eu.com/Home/General/2013/5/Dahon-Sales-Conference-in-Positive-Mood-Again-1266922W/>

Wilson, D. (2004). *Bicycling Science*. MIT Press.



## Appendix 1 – Project Plan and Gantt Chart

ID	Task Mode	Task Name	Duration	Start	Finish	Predecessors
1		Project Assignment	1 day	Mon 06/10/14	Mon 06/10/14	
2		Project Schedule	9 days	Tue 07/10/14	Fri 17/10/14	1
3		Proposal	9 days	Tue 07/10/14	Fri 17/10/14	1
4		Problem Identification and Formulation	2 days	Tue 07/10/14	Wed 08/10/14	1
5		Initial Considerations and Ideas	3 days	Thu 09/10/14	Mon 13/10/14	1,4
6		Statement of Purpose	3 days	Tue 14/10/14	Thu 16/10/14	1,4
7		Final Contract	1 day	Fri 17/10/14	Fri 17/10/14	6
8		Research	12 days	Tue 14/10/14	Wed 29/10/14	
9		Market Research	10 days	Tue 14/10/14	Mon 27/10/14	
10		Existing Alternatives	2 days	Tue 14/10/14	Wed 15/10/14	5
11		Patents/Regulations	4 days	Tue 14/10/14	Fri 17/10/14	5
12		Market Needs	2 days	Fri 17/10/14	Mon 20/10/14	5,10
13		Consumer Survey	5 days	Tue 21/10/14	Mon 27/10/14	5,12
14		Bike Components	5 days	Thu 23/10/14	Wed 29/10/14	
15		Wheels	5 days	Thu 23/10/14	Wed 29/10/14	
16		Gears	5 days	Thu 23/10/14	Wed 29/10/14	
17		Brakes	5 days	Thu 23/10/14	Wed 29/10/14	
18		Frame/Materials	5 days	Thu 23/10/14	Wed 29/10/14	
19		Folding Mechanism	5 days	Thu 23/10/14	Wed 29/10/14	
20		Power	5 days	Thu 23/10/14	Wed 29/10/14	
21		Literature Review	5 days	Mon 20/10/14	Fri 24/10/14	11
22		Funding	30 days	Mon 01/12/14	Fri 13/02/15	
23		Sponsorship	29 days	Mon 01/12/14	Thu 12/02/15	
24		Grants	29 days	Mon 01/12/14	Thu 12/02/15	
25		Budget	1 day	Fri 28/11/14	Fri 28/11/14	23,24
26		Conceptual Design	22 days	Tue 28/10/14	Wed 26/11/14	
27		Pugh's Design Process	17 days	Tue 28/10/14	Wed 19/11/14	
28		Product Design Specification	2 days	Tue 28/10/14	Wed 29/10/14	8
29		Concept Generation	5 days	Thu 30/10/14	Wed 05/11/14	28
30		Controlled Convergence Matrices	3 days	Thu 06/11/14	Mon 10/11/14	29
31		Final Concept Drawings	7 days	Tue 11/11/14	Wed 19/11/14	30
32		Design Review	2 days	Thu 20/11/14	Fri 21/11/14	31
33		Contingency Time	3 days	Mon 24/11/14	Wed 26/11/14	32
34		Interim Report	8 days	Wed 26/11/14	Fri 05/12/14	32
35		CAD Design	21 days	Mon 26/01/15	Mon 23/02/15	
36		Individual Parts	15 days	Mon 26/01/15	Fri 13/02/15	
37		Wheels	7 days	Mon 26/01/15	Tue 03/02/15	
38		Frame	7 days	Mon 26/01/15	Tue 03/02/15	
39		Brakes	7 days	Mon 26/01/15	Tue 03/02/15	
40		Suspension	7 days	Mon 26/01/15	Tue 03/02/15	
41		Gear System	7 days	Mon 26/01/15	Tue 03/02/15	
42		Power Transmission	7 days	Mon 26/01/15	Tue 03/02/15	
43		Steering	7 days	Mon 26/01/15	Tue 03/02/15	
44		Overall Model	4 days	Wed 04/02/15	Mon 09/02/15	37,38,39,40,41,
45		Contingency Time	3 days	Tue 10/02/15	Thu 12/02/15	44
46		Analysis	6 days	Fri 13/02/15	Fri 20/02/15	45
47		Stress Analysis	6 days	Fri 13/02/15	Fri 20/02/15	45
48		Max Load Analysis	6 days	Fri 13/02/15	Fri 20/02/15	45
49		Project Review	1 day	Mon 23/02/15	Mon 23/02/15	
50		Safety Focus	1 day	Mon 23/02/15	Mon 23/02/15	48
51		Manufacturing Focus	1 day	Mon 23/02/15	Mon 23/02/15	48
52		Manufacture	44 days	Tue 24/02/15	Fri 24/04/15	51
53		Acquire Materials	20 days	Tue 24/02/15	Mon 23/03/15	51
54		Equipment Training	1 day	Tue 24/02/15	Tue 24/02/15	51
55		Technician Requirement	39 days	Tue 24/02/15	Fri 17/04/15	51
56		Building of prototype	38 days	Wed 25/02/15	Fri 17/04/15	54
57		Contingency Time	5 days	Mon 20/04/15	Fri 24/04/15	55
58		Interim Reviews	40 days	Wed 25/02/15	Tue 21/04/15	54
59		Testing	2 days	Mon 20/04/15	Tue 21/04/15	56
60		Business Plan	64 days	Mon 26/01/15	Thu 23/04/15	
61		Website	64 days	Mon 26/01/15	Thu 23/04/15	
62		Final Project Review	1 day	Fri 24/04/15	Fri 24/04/15	61
63		Final Write up and Presentation	65 days	Mon 26/01/15	Fri 24/04/15	
64		Functional Prototype Competition Day	1 day	Sat 02/05/15	Sat 02/05/15	

Appendix1 Figure 1 - Project Plan

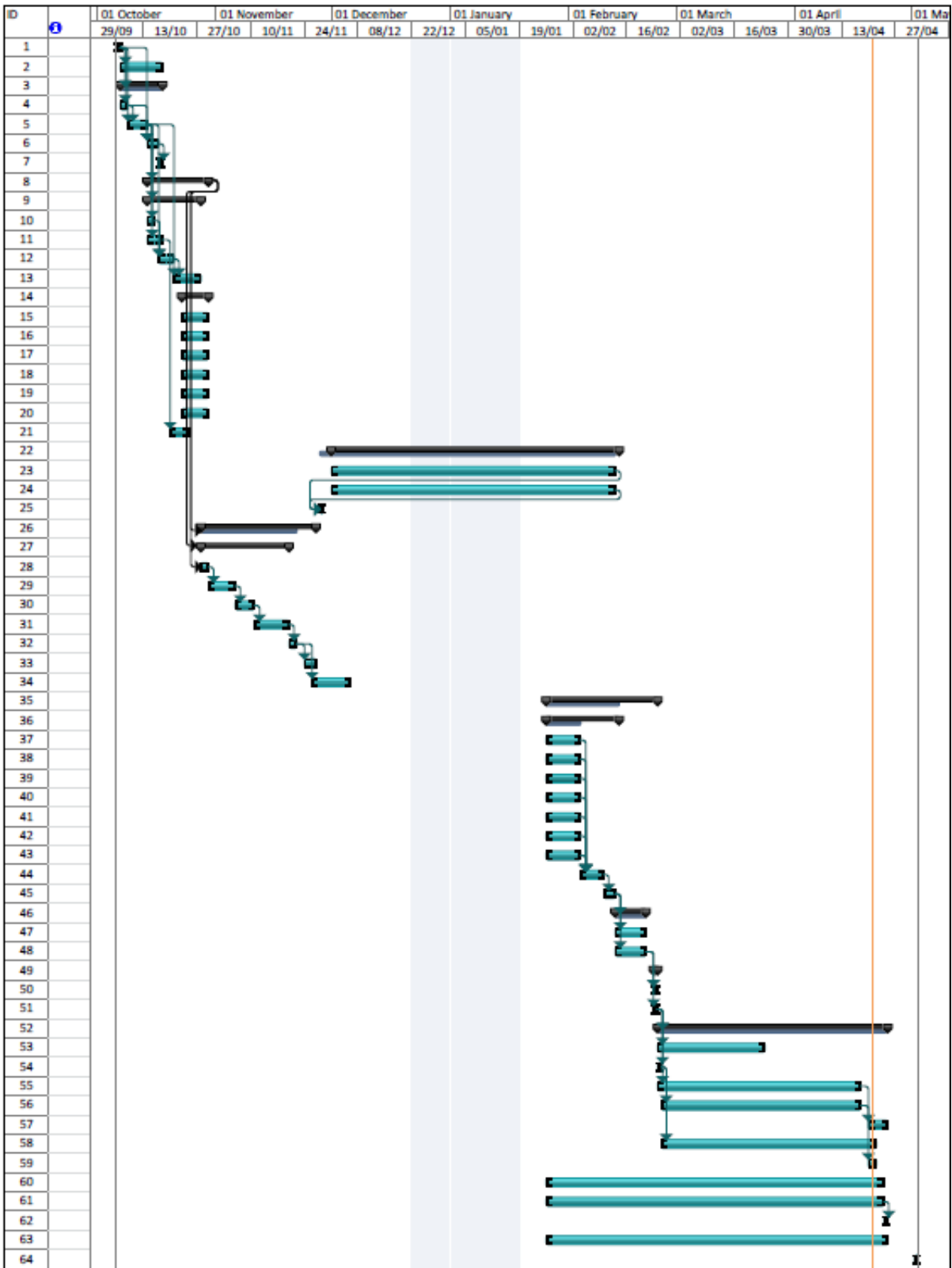

Appendix 1 Figure 1 - Gantt Chart

## Appendix 2 -Group Availability

	Monday						Tuesday						Wednesday						Thursday						Friday											
	C	G	A	J	S	Ge	C	G	A	J	S	Ge	C	G	A	J	S	Ge	C	G	A	J	S	Ge	C	G	A	J	S	Ge	C	G	A	J	S	Ge
9.00-10.00																																				
10.00-11.00																																				
11.00-12.00																																				
12.00-13.00																																				
13.00-14.00																																				
14.00-15.00																																				
15.00-16.00																																				
16.00-17.00																																				

Appendix 2 Table 1 - Group member's timetable Semester 1

	Monday						Tuesday						Wednesday						Thursday						Friday											
	C	G	A	J	S	Ge	C	G	A	J	S	Ge	C	G	A	J	S	Ge	C	G	A	J	S	Ge	C	G	A	J	S	Ge	C	G	A	J	S	Ge
9.00-10.00																																				
10.00-11.00																																				
11.00-12.00																																				
12.00-13.00																																				
13.00-14.00																																				
14.00-15.00																																				
15.00-16.00																																				
16.00-17.00																																				

Appendix 2 Table 2 - Group members timetable Semester 2

Calum	C
Gareth	G
Andrew	A
Jorge	J
Sabrina	S
Gemma	Ge
Not Available	
Available	

Appendix 2 Table 3 - Key for tables 1 and 2

## Appendix 3 – Time Spent on Project as a Group

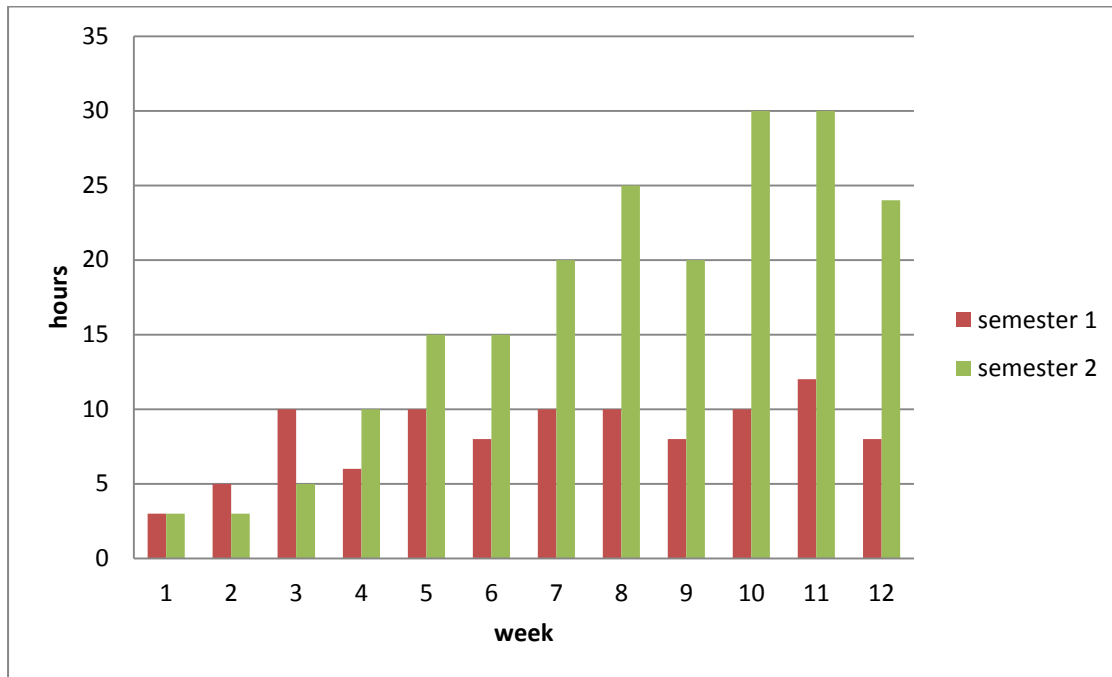

Appendix 3 Figure 2 -Time spent on the project as a whole group

## Appendix 4- Existing Products

### Stowabike Folding City Compact Bike



<b>Price:</b> £119.99	<b>Weight:</b> 17.7 kg
<b>Frame:</b> 20" steel folding frame	<b>Fork:</b> Steel 20", Folded
<b>Dimensions:</b> W 24" x L 34" x H 32"	<b>Gears:</b> Microshift 6 speed grip shifter
<b>Rear Derailleur:</b> Shimano RD-TY18S 6 speed	<b>Rims:</b> 20" single wall
<b>Mudguards:</b> built in steel mudguards	<b>Tyres:</b> New Well 20x2.125"
<b>Pedals:</b> VP-872N	<b>Chain:</b> New Well E60
<b>Brakes:</b> steel V-Brakes	<b>Handlebar:</b> Steel with ZOOM stem

### Stowabike Folding Dual Suspension Mountain Bike



<b>Price:</b> £110	<b>Weight:</b> 18.2 kg
<b>Frame:</b> 26" steel Stowabike folding frame	<b>Fork:</b> Zoom steel suspension 26" fork
<b>Shock:</b> Alloy body spring shock, 750lbs/in	<b>Gears:</b> 18
<b>Rims:</b> Single wall alloy	<b>Brake:</b> resin steel v-brakes
<b>Handlebar:</b> steel handlebar with steel stem	

## Electric bicycles

### Cyclamatic FoldAway Electric Bike



<b>Price:</b> £499.99	<b>Weight (including battery):</b> 23 kg
<b>Range:</b> 30km (range if no pedalling)	<b>Maximum load:</b> 110 kg

### Cyclamatic FoldAway Electric Bike



<b>Price:</b> £1775	<b>Range:</b> 5.6AH = 10 miles, 8.2AH = 15miles, 10AH = 20+ miles
<b>Speed:</b> 18mph (max with no pedalling)	

## Appendix 5 – Consumer Survey and Results

### How far do you commute?

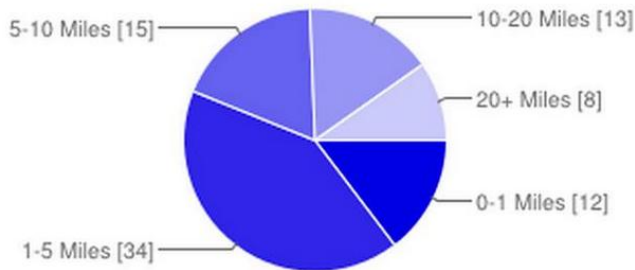

0-1 Miles	<b>12</b>	14.5 %
1-5 Miles	<b>34</b>	41 %
5-10 Miles	<b>15</b>	18.1 %
10-20 Miles	<b>13</b>	15.7 %
20+ Miles	<b>8</b>	9.6 %

### How Old are you

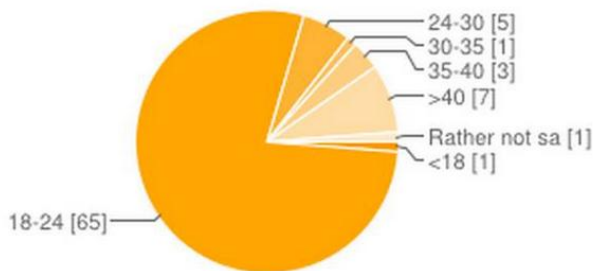

<18	<b>1</b>	1.2 %
18-24	<b>65</b>	78.3 %
24-30	<b>5</b>	6 %
30-35	<b>1</b>	1.2 %
35-40	<b>3</b>	3.6 %
>40	<b>7</b>	8.4 %
Rather not say	<b>1</b>	1.2 %

### How do you Commute?

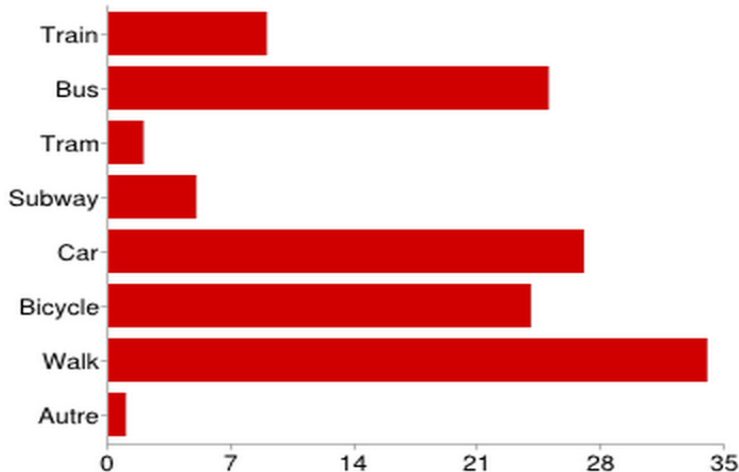

Train	<b>9</b>	11 %
Bus	<b>25</b>	30 %
Tram	<b>2</b>	2 %
Subway	<b>5</b>	6 %
Car	<b>27</b>	33 %
Bicycle	<b>24</b>	29 %
Walk	<b>34</b>	41 %
Autre	<b>1</b>	1 %

### If you use a bicycle, how often do you use it?

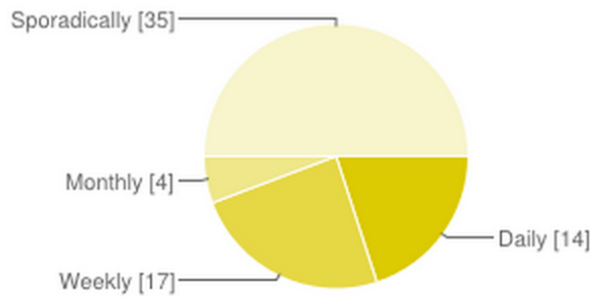

Daily	<b>14</b>	17 %
Weekly	<b>17</b>	20 %
Monthly	<b>4</b>	5 %
Sporadically	<b>35</b>	42 %

### How much would you expect to pay for a folding bike?

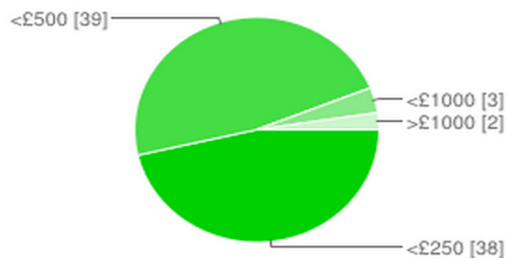

<£250	<b>38</b>	46 %
<£500	<b>39</b>	47 %
<£1000	<b>3</b>	4 %
>£1000	<b>2</b>	2 %

### Would you want a full size frame or compact frame

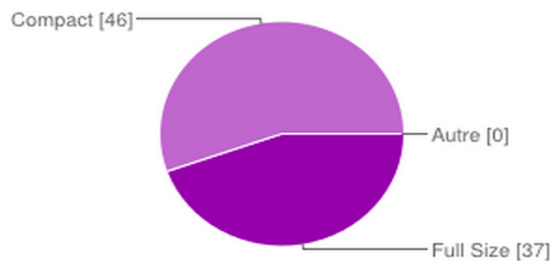

Full Size	<b>37</b>	45 %
Compact	<b>46</b>	55 %
Autre	<b>0</b>	0 %

### What kind of drive would you like?

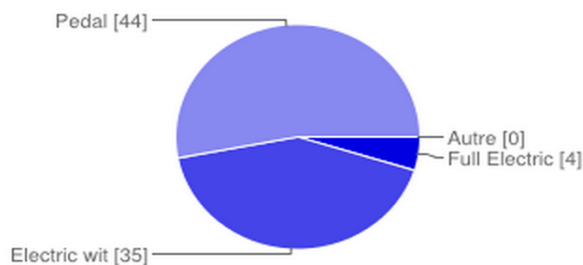

Full Electric	<b>4</b>	5 %
Electric with pedal option	<b>35</b>	42 %
Pedal	<b>44</b>	53 %
Autre	<b>0</b>	0 %



### Maximum folding time?

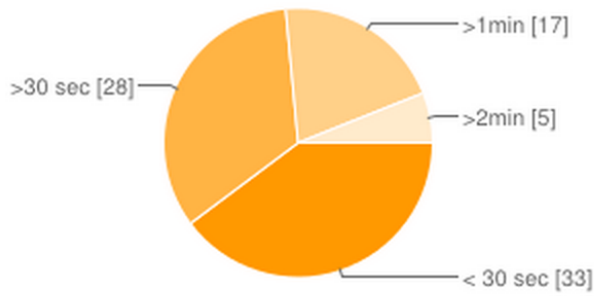

< 30 sec	<b>33</b>	40 %
>30 sec	<b>28</b>	34 %
>1min	<b>17</b>	20 %
>2min	<b>5</b>	6 %

### What would be most convenient carrying method?

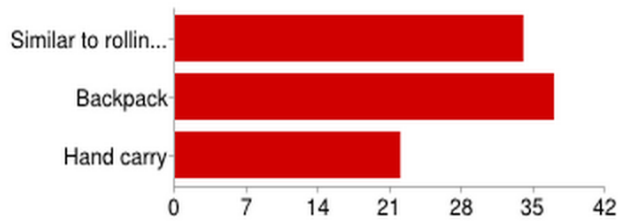

Similar to rolling luggage/trolley	<b>34</b>	41 %
Backpack	<b>37</b>	45 %
Hand carry	<b>22</b>	27 %

### Wheel size you would prefer?

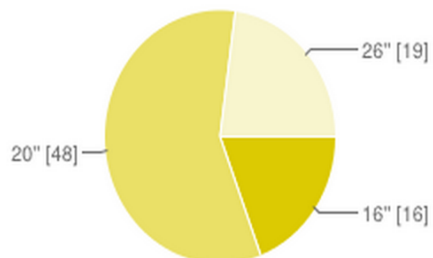

16"	<b>16</b>	19 %
20"	<b>48</b>	58 %
26"	<b>19</b>	23 %

## Appendix 6 – Initial Concepts

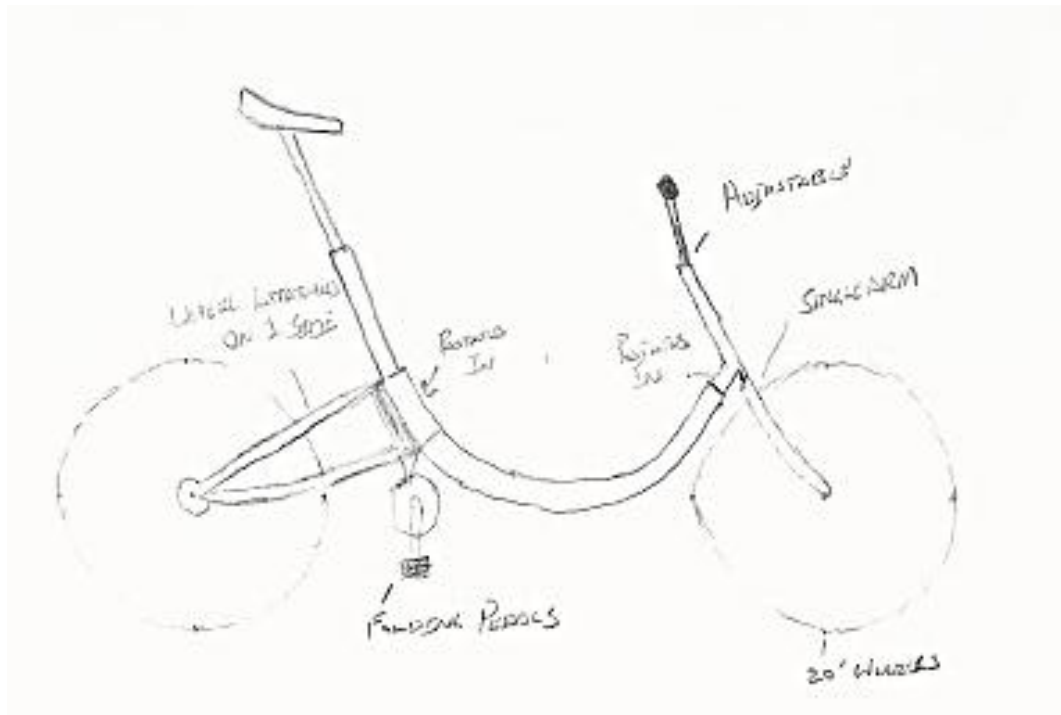

Appendix 6 Figure 1 - Concept 1

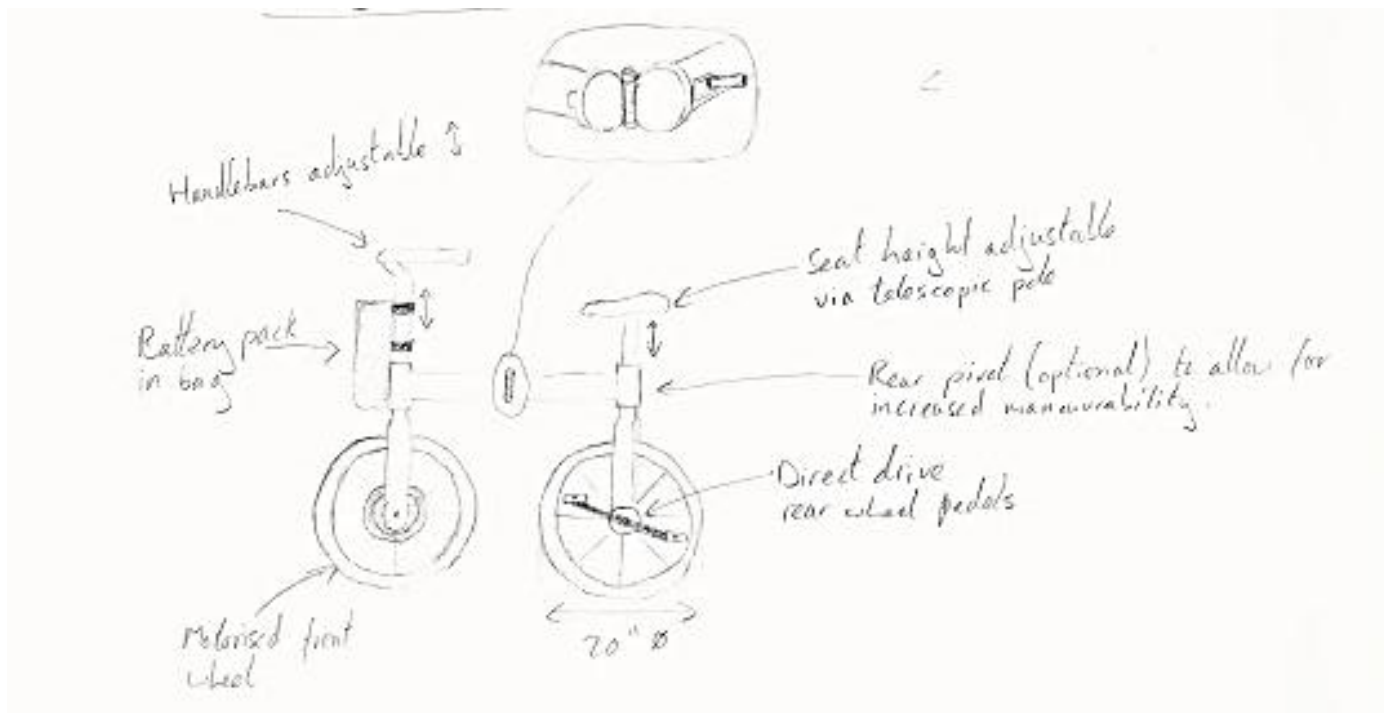

Appendix 6 Figure 2 - Concept 2

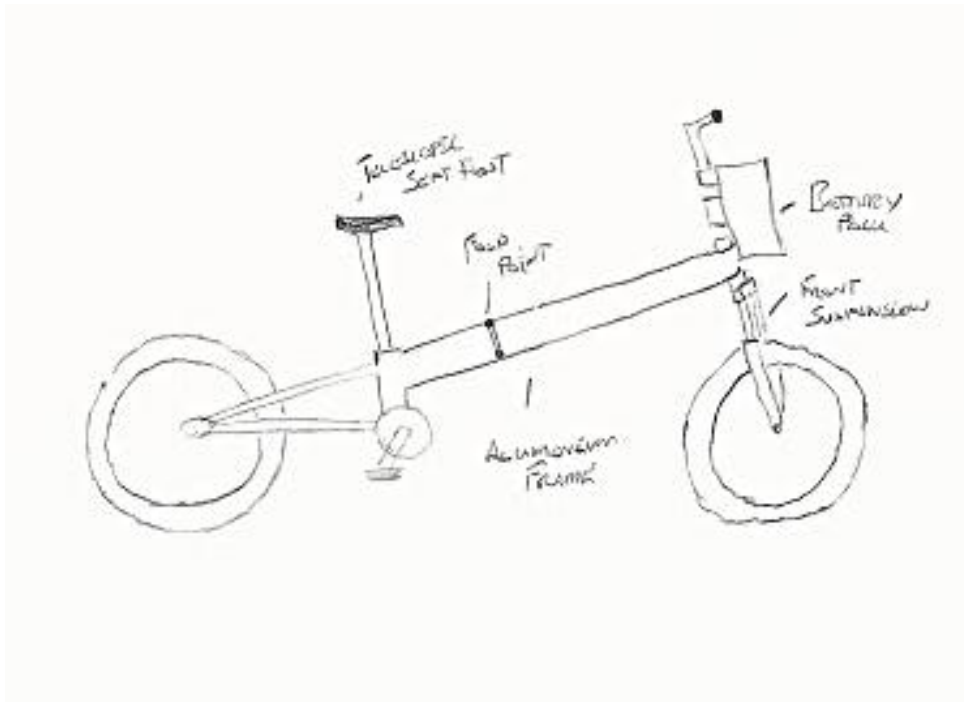

Appendix 6 Figure 3 - Concept 3

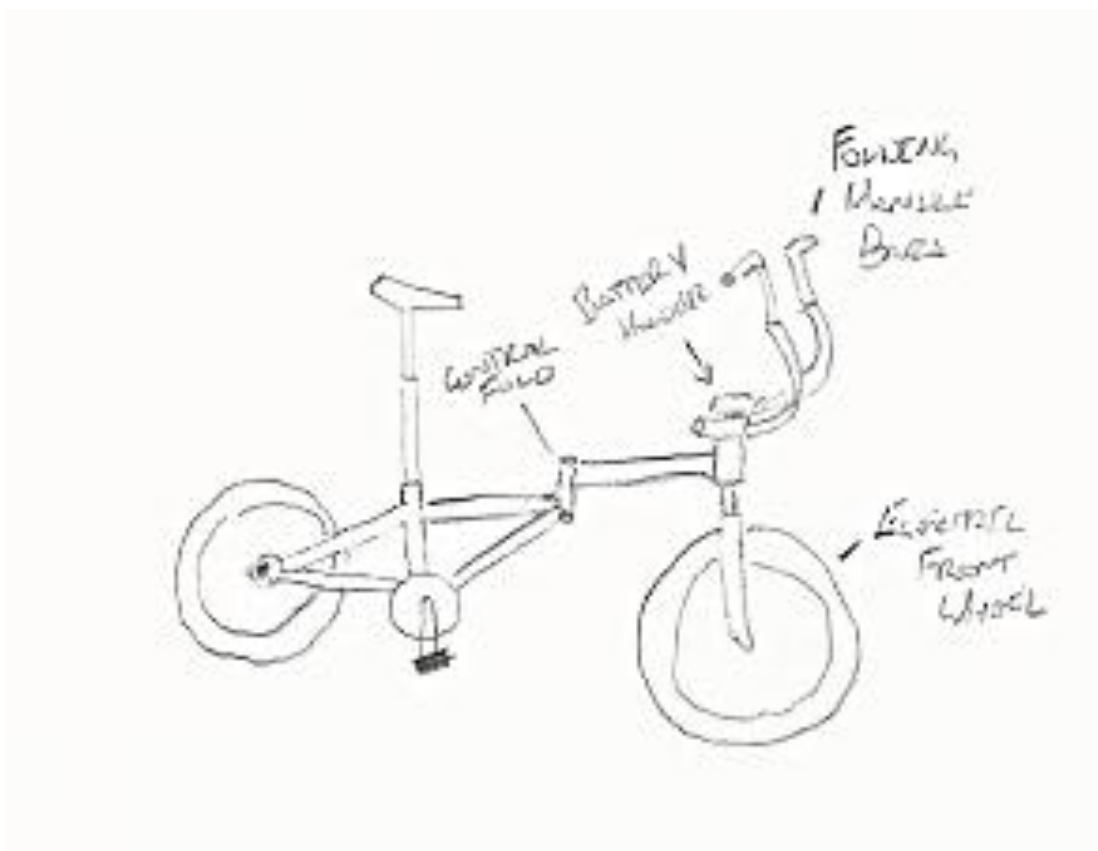

Appendix 6 Figure 4 - Concept 4

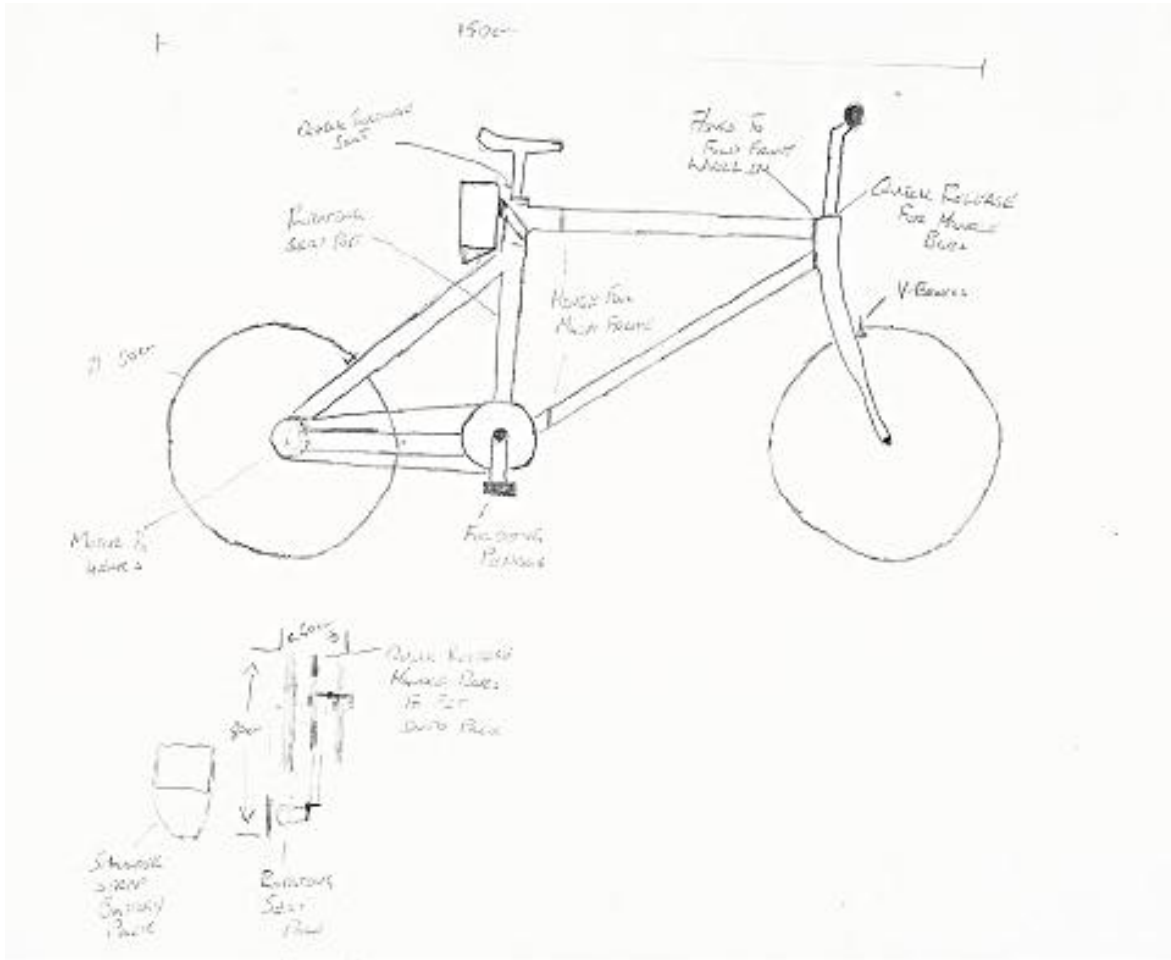

Appendix 6 Figure 5 - Concept 5

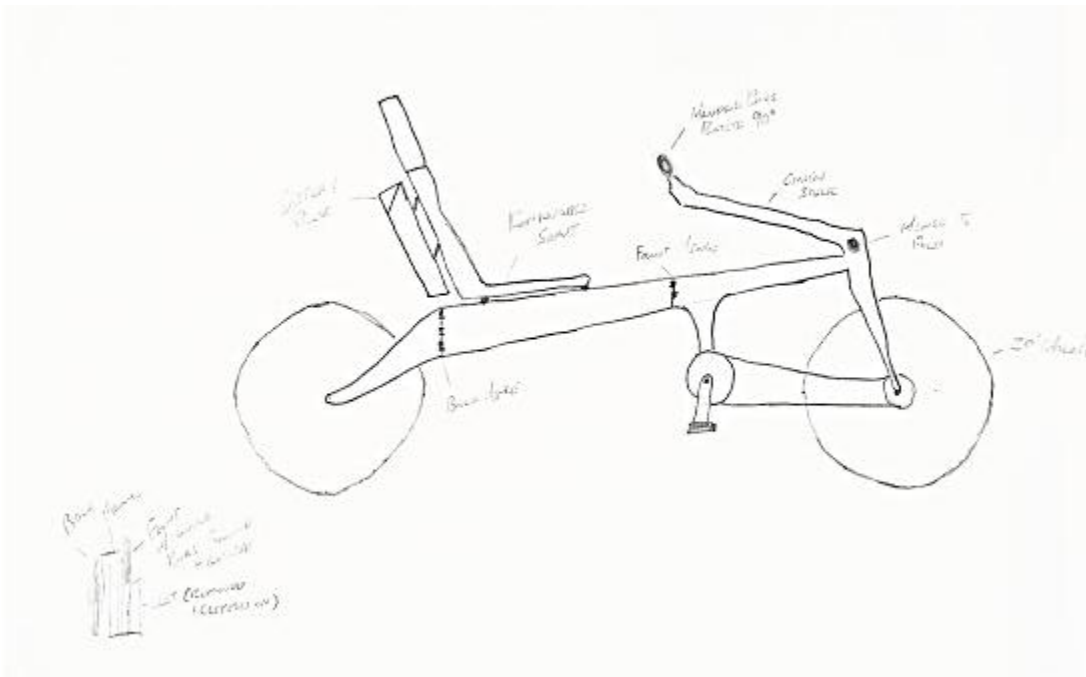

Appendix 6 Figure 6 - Concept 6

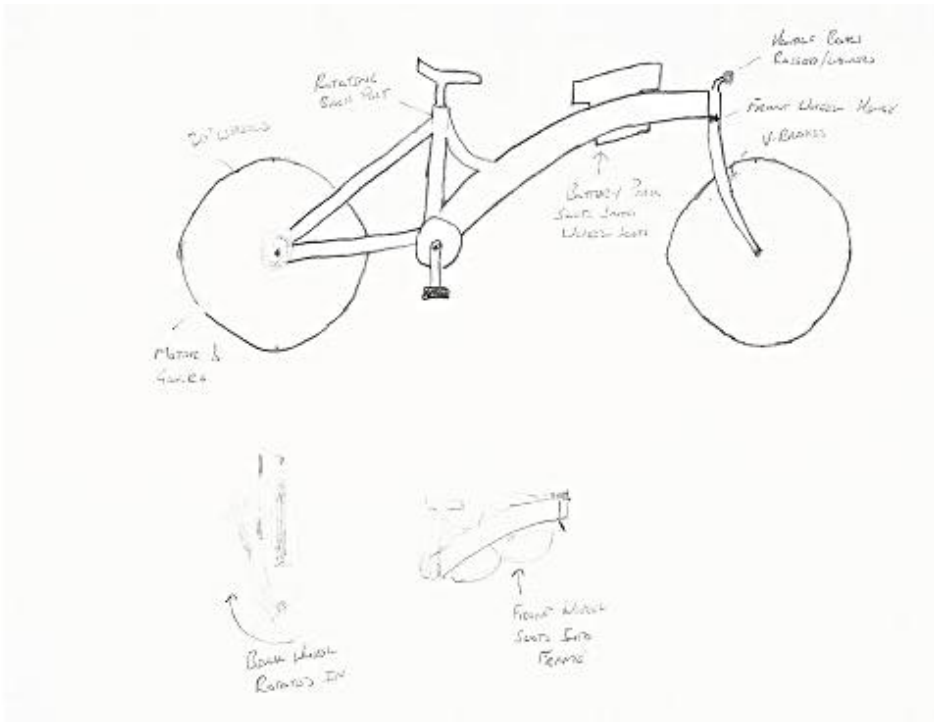

Appendix 6 Figure 7 - Concept 7

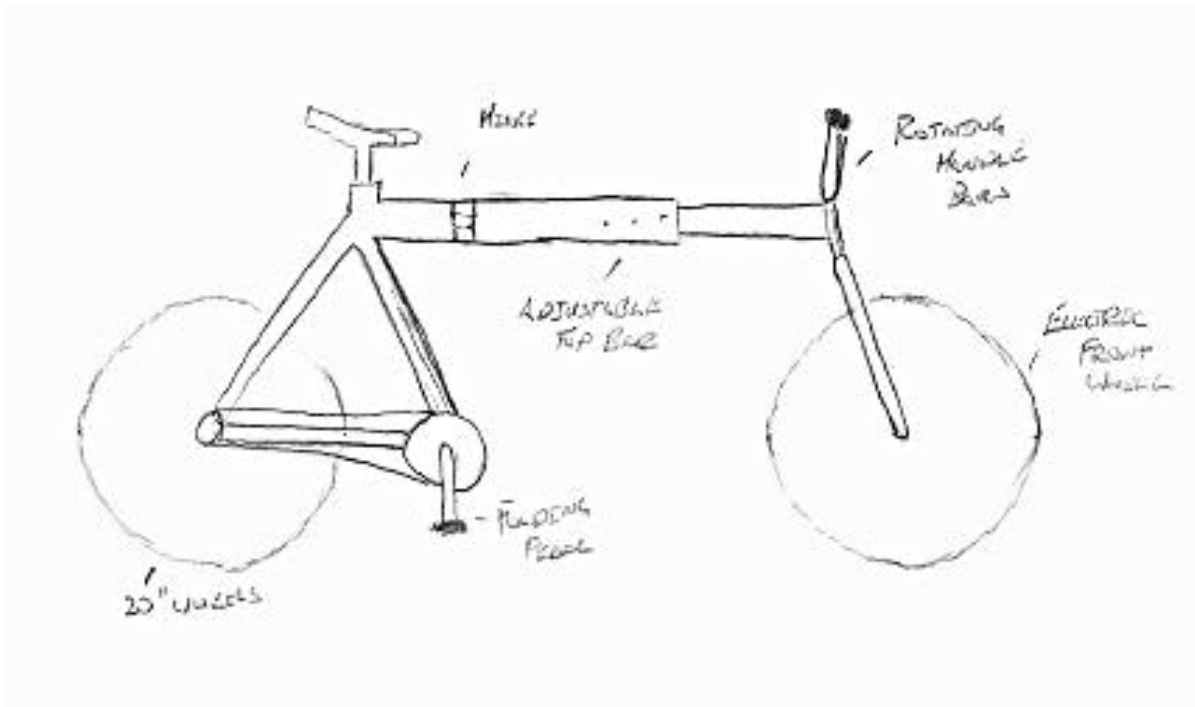

Appendix 6 Figure 8 - Concept 8

## Appendix 7- Convergence matrix 1

Concept:	1	2	3	4	5	6	7	8
Ride comfort	=	-	+	=	R	++	=	=
Folded Size	+	+	--	--	E	-	=	++
Ease of folding	+	++	+	+	F	-	+	+
Weight	-	+	-	=	E	-	+	-
Aesthetics	++	-	+	=	R	+	+	=
Ergonomics	+	--	-	=	E	-	=	+
Feasibility	-	+	=	-	N	-	-	+
Complex Components	-	=	+	=	C	-	=	++
Manufacture Price	-	+	-	-	E	--	+	-
Total +	5	6	4	1	///////// /	3	4	7
Total -	4	4	5	4	///////// /	8	1	2
Total =	1	0	1	5	///////// /	0	4	3
Net Score	1	2	-1	-3	///////// /	-5	3	5

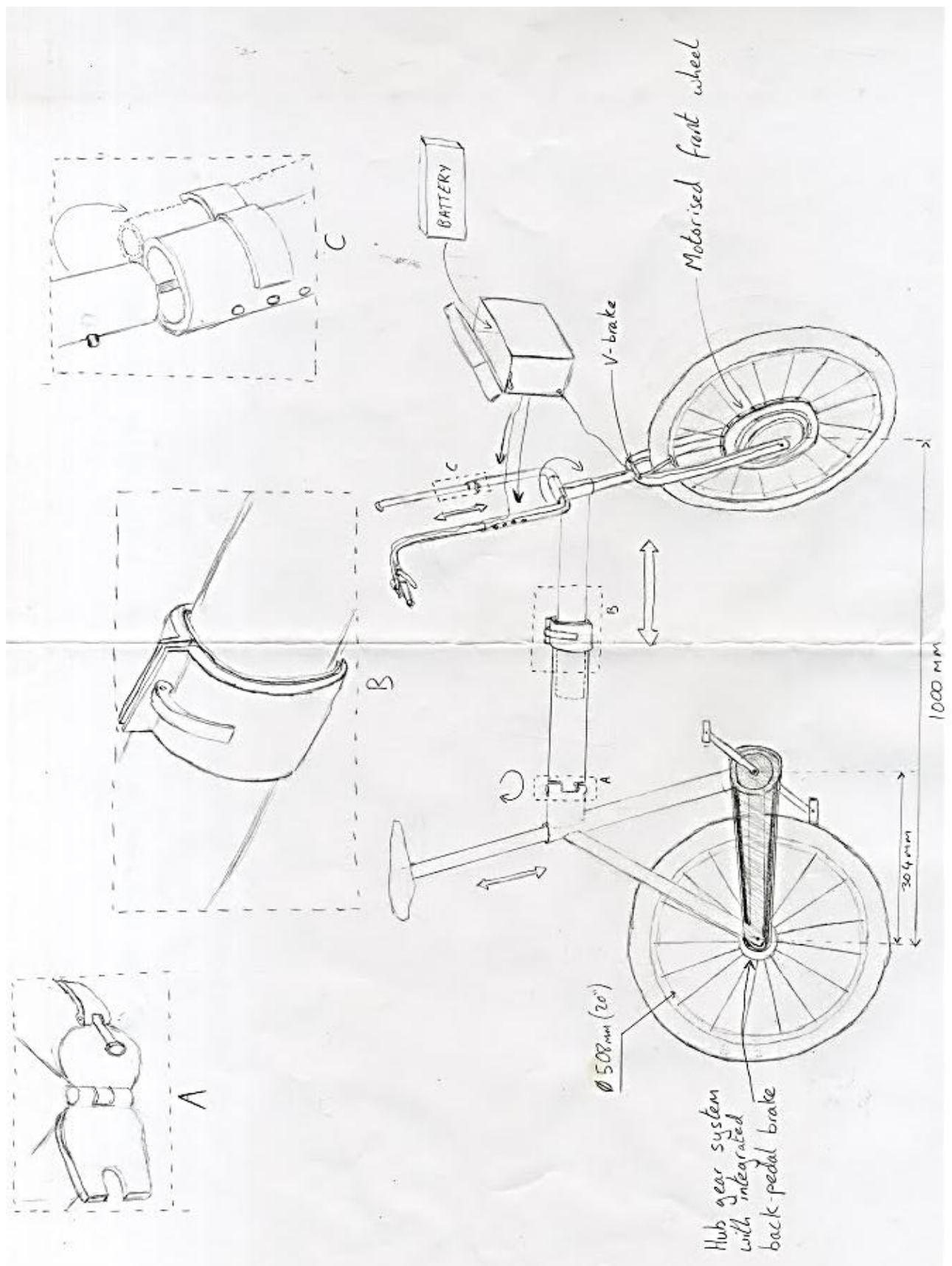

Appendix 7 Figure 9 - Final Concept

## Appendix 8: Handlebars for bending calculations

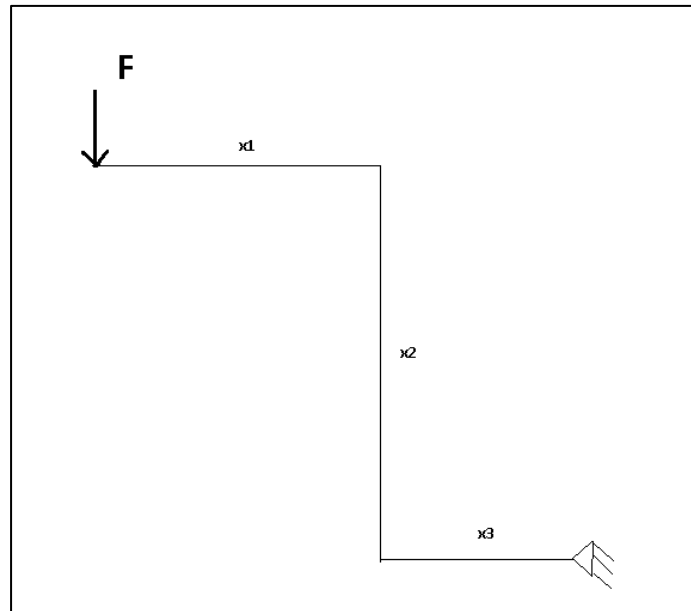

x1: top bar length

x2:vertical bar length

x3: bottom bar length

F= force applied



## Appendix 9 – Costing Spreadsheet

# CDIO Challenge

## Costs estimation (includes postage)

Frame components (material+fabrication)	Top spec prototype	Simplified prototype	Actual cost
Rear triangle	£70	£40	£81.60
Seat tube	£20	£10	£84.00
Telescopic top tube (large tube)	£40	£30	£46.36
Telescopic top tube (small tube)	£20	£10	£42.02
Head tube	£20	£10	£41.30
Steerer	£20	£10	£13.69
Front forks	£40	£30	£40.06
Hinges and clamps	£70	£50	£40.00
Handlebars	£60	£40	£15.30
Fixtures, lugs, attachment points	£50	£50	£58.38
<b>Total</b>	<b>£ 410.00</b>	<b>£ 280.00</b>	<b>£462.71</b>

Wheels, brakes and power	Top spec prototype	Simplified prototype	Actual Cost
Front wheel including electric conversion kit	£250	N/A	£450.00
Battery	£250	N/A	£0.00
Rear wheel	£40	£20	£21.00
Front V brakes	£20	£10	£0.00
Tyres	£25	N/A	£50.00
Bottom bracket	£15	£10	£10.99
Crank	£20	£10	£25.00
Rear hub gear/coaster brake	£75	N/A	£16.58
<b>Total</b>	<b>£</b>	<b>£</b>	<b>£573.57</b>

	<b>695.00</b>	<b>50.00</b>	
--	---------------	--------------	--

Other	Top spec prototype	Simplified prototype	Actual cost
Aesthetics e.g. Logo, paint, primer	£50	£10	£21.85
Lightweight seat	£20	£20	£20.00
Chain	£10	£10	£11.99
Headset	£40	£20	£39.99
Bag for carrying bike folded	£40	N/A	N/A
<b>Total</b>	<b>£ 160.00</b>	<b>£ 60.00</b>	<b>£93.83</b>

Program	With additional funds	With current funds	Actual cost
Travel to Belfast	£400	£400	Covered by Faculty
Team t-shirts with logo	£60	N/A	
Other (Gear changer)			£21.71
<b>Total</b>	<b>£ 460.00</b>	<b>£ 400.00</b>	<b>£21.71</b>

<b>Total Expenses</b>	Top Spec total	Simplified total	Actual total
	<b>£ 1,725.00</b>	<b>£ 790.00</b>	<b>£ 1,151.82</b>



## **Appendix 11 - Engineering Drawings**



Appendix 10: Figure 1- finished bicycle



Appendix 10: Figure 2- Finished bicycle (zoomed)



Appendix 10: Figure 3- Folded bicycle

## **Appendix 12- Finished Bicycle**

2

1

B

B

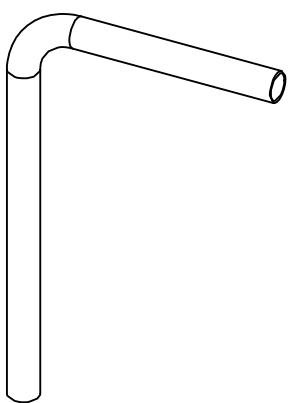
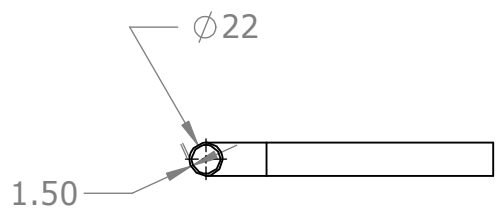
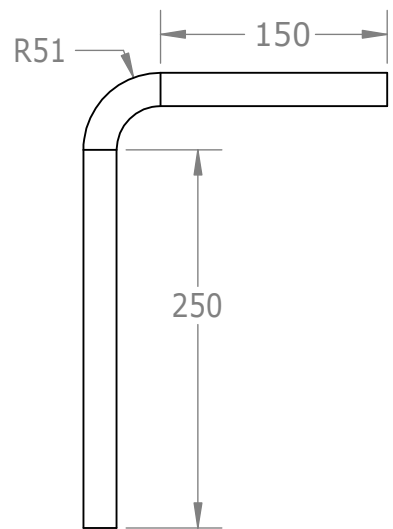

A

A

**PROPRIETARY AND CONFIDENTIAL**  
 THE INFORMATION CONTAINED IN THIS DRAWING IS THE SOLE PROPERTY OF UNIVERSITY OF STRATHCLYDE. ANY REPRODUCTION IN PART OR AS A WHOLE WITHOUT THE WRITTEN PERMISSION OF UNIVERSITY OF STRATHCLYDE IS PROHIBITED.

**DESCRIPTION:**  
 HANDLE BARS REQUIRE 90 DEGREE BEND 250MM ALONG THE TUBE  
 TIG WELDING REQUIRED.

DIMENSIONS ARE IN MILLIMETRES  
 TOLERANCES: +3%  
 MATERIAL: STAINLESS STEEL  
 DWG. NO. **HANDLE BARS** REV.  
 SCALE: 1:5 WEIGHT: SHEET 1 OF 1

2

1



2

1

B

B

A

A

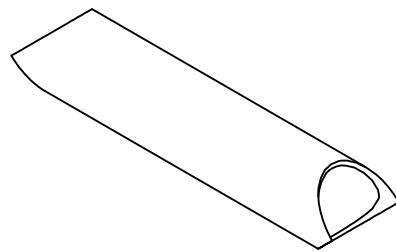
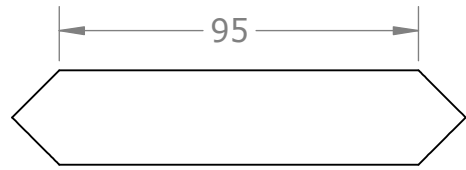
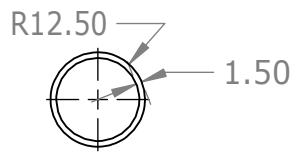

**PROPRIETARY AND CONFIDENTIAL**

THE INFORMATION CONTAINED IN THIS DRAWING IS THE SOLE PROPERTY OF UNIVERSITY OF STRATHCLYDE. ANY REPRODUCTION IN PART OR AS A WHOLE WITHOUT THE WRITTEN PERMISSION OF UNIVERSITY OF STRATHCLYDE IS PROHIBITED.

**DESCRIPTION:**

LOWER HANDLEBARS ARE THE HORIZONTAL PART OF THE HANDLE BARS WITH QUICK RELEASE CLAMPS WELDED TO EITHER SIDE FOR THE UPPER HANDLE BARS INSERTED. PART IS CLAMPED IN THE CENTRE BY THE STEM

TIG WELDING REQUIRED.

DIMENSIONS ARE IN MILLIMETRES

TOLERANCES: ±3%

MATERIAL: STAINLESS STEEL

SIZE	DWG. NO.	REV.
<b>A</b>	<b>LOWER HANDLEBAR</b>	

SCALE: 1:2 WEIGHT:

SHEET 1 OF 1

2

1

2

1

B

B

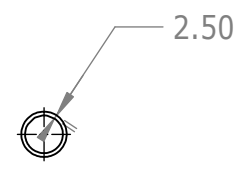
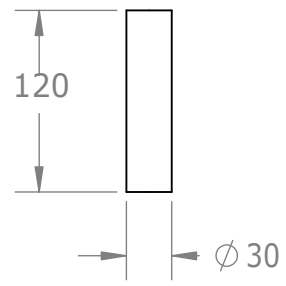

A

A

**PROPRIETARY AND CONFIDENTIAL**

THE INFORMATION CONTAINED IN THIS DRAWING IS THE SOLE PROPERTY OF UNIVERSITY OF STRATHCLYDE. ANY REPRODUCTION IN PART OR AS A WHOLE WITHOUT THE WRITTEN PERMISSION OF UNIVERSITY OF STRATHCLYDE IS PROHIBITED.

**DESCRIPTION:**

HEAD TUBE HAS HEADSET BEARINGS INSERTED INTO THE TOP AND BOTTOM OF TUBE.  
TIG WELDING REQUIRED.

DIMENSIONS ARE IN MILLIMETRES

TOLERANCES: +3%

MATERIAL: STAINLESS STEEL

SIZE DWG. NO.

**A**

**HEADTUBE**

REV.

SCALE: 1:5

WEIGHT:

SHEET 1 OF 1

2

1

2

1

B

B

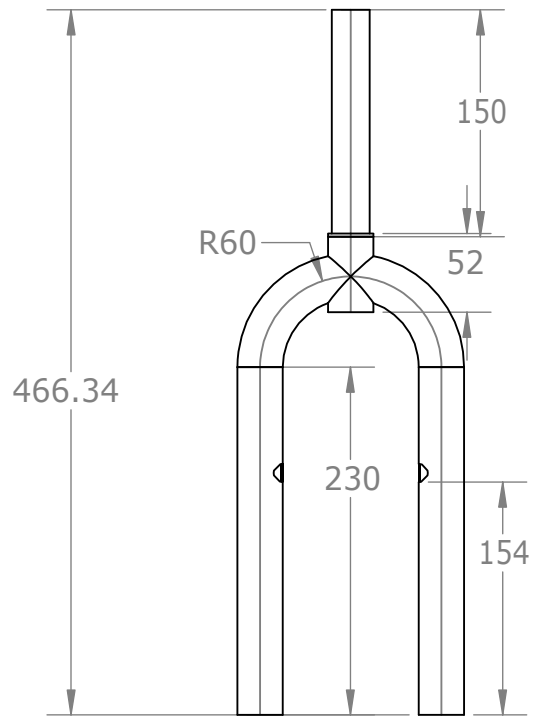
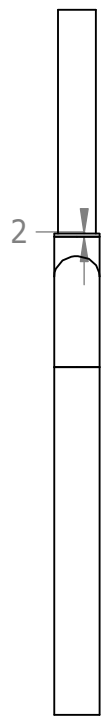

A

A

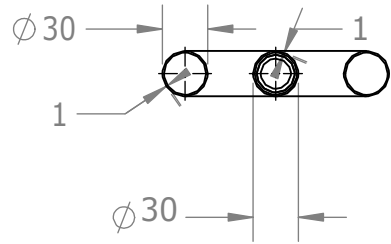
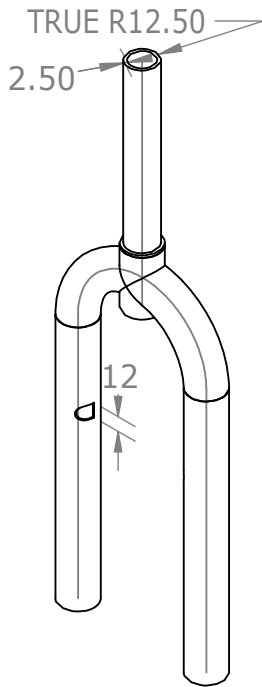

**PROPRIETARY AND CONFIDENTIAL**  
 THE INFORMATION CONTAINED IN THIS DRAWING IS THE SOLE PROPERTY OF UNIVERSITY OF STRATHCLYDE. ANY REPRODUCTION IN PART OR AS A WHOLE WITHOUT THE WRITTEN PERMISSION OF UNIVERSITY OF STRATHCLYDE IS PROHIBITED.

**DESCRIPTION:**  
 FRONT FORK REQUIRES THE UPPER TUBE, THE STEERER TO BE WELDED TO THE PREVIOUSLY BEND FORK BLADES, LOWER BARS. THE STEERER IS CONNECTED BY BEARINGS TO THE HEAD TUBE AND THE STEM BY A CLAMP. THE FORK BLADES ARE WELDED TO THE FRONT DROPOUTS.  
 TIG WELDING REQUIRED.

DIMENSIONS ARE IN MILLIMETRES

TOLERANCES:  $\pm 3\%$

MATERIAL: STAINLESS STEEL

SIZE <b>A</b>	DWG. NO. <b>FRONT FORK</b>	REV.
SCALE: 1:5	WEIGHT:	SHEET 1 OF 1

2

1

2

1

B

B

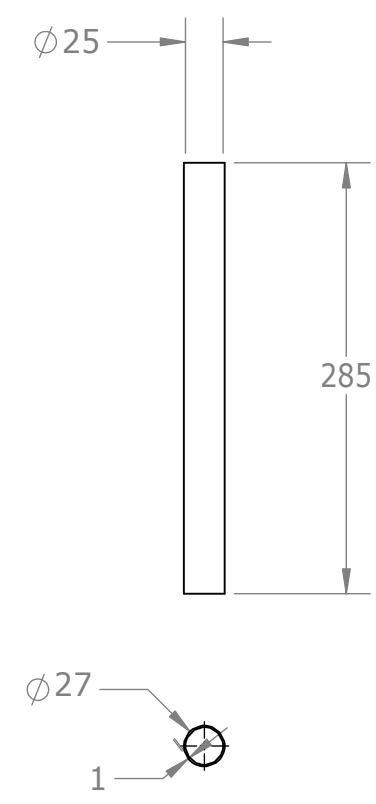
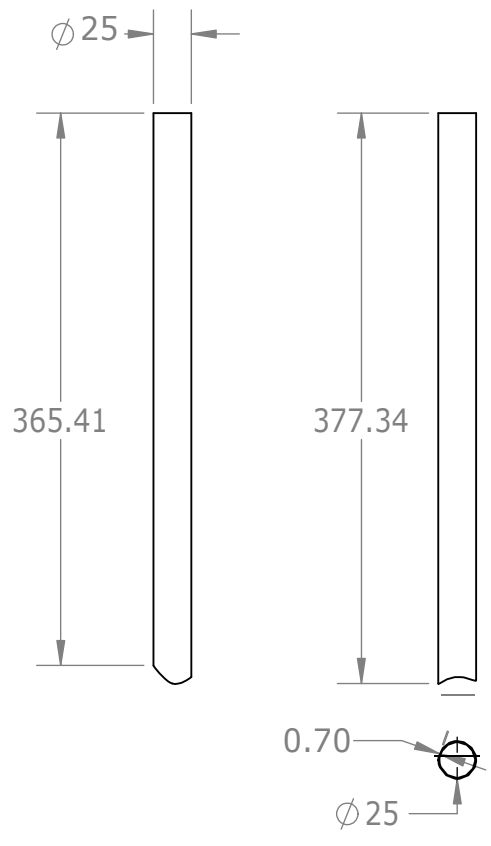

A

A

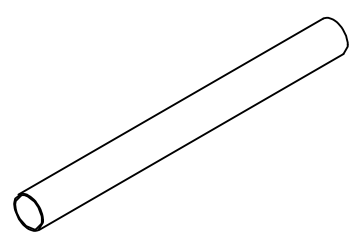
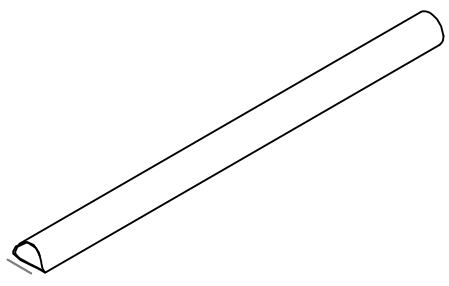

**PROPRIETARY AND CONFIDENTIAL**

THE INFORMATION CONTAINED IN THIS DRAWING IS THE SOLE PROPERTY OF UNIVERSITY OF STRATHCLYDE. ANY REPRODUCTION IN PART OR AS A WHOLE WITHOUT THE WRITTEN PERMISSION OF UNIVERSITY OF STRATHCLYDE IS PROHIBITED.

**DESCRIPTION:**

TO THE LEFT OF THIS FIGURE IS THE FRONT SECTION OF THE TOP TUBE, WITH THE CURVED END CUT TO FIT THE HEAD TUBE AND WELDED. THE FLAT SECTION INSERTS INTO MID TUBE.

TO THE RIGHT OF THE FIGURE IS THE MID TUBE IN WHICH ONE END WELDS TO THE FRONT HINGE PART

TIG WELDING REQUIRED.

DIMENSIONS ARE IN MILLIMETRES

TOLERANCES: +3%

MATERIAL: STAINLESS STEEL

SIZE	DWG. NO.	REV.
<b>A</b>	<b>FRONT/MID TUBE</b>	

SCALE: 1:5

WEIGHT:

SHEET 1 OF 1

2

1



2

1

B

B

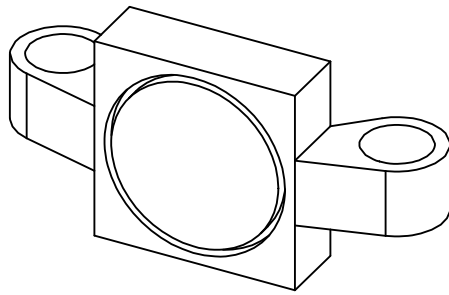
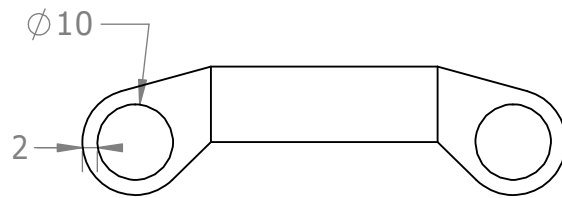
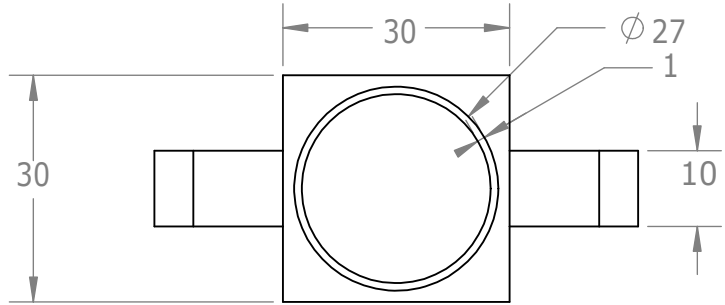
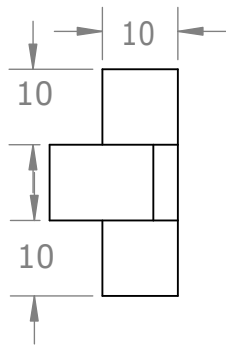

A

A

**PROPRIETARY AND CONFIDENTIAL**  
 THE INFORMATION CONTAINED IN THIS DRAWING IS THE SOLE PROPERTY OF UNIVERSITY OF STRATHCLYDE. ANY REPRODUCTION IN PART OR AS A WHOLE WITHOUT THE WRITTEN PERMISSION OF UNIVERSITY OF STRATHCLYDE IS PROHIBITED.

**DESCRIPTION:**  
 REAR PART OF HINGE WITH INSET GROOVE FOR BACK TUBE TO BE WELDED.  
 PART MAKES UP THE REAR HALF OF THE HINGE.  
 TIG WELDING REQUIRED.

DIMENSIONS ARE IN MILLIMETRES

TOLERANCES: +3%

MATERIAL: STAINLESS STEEL

SIZE **A** DWG. NO.

**REAR HINGE**

REV.

SCALE: 1:1

WEIGHT:

SHEET 1 OF 1

2

1

2

1

B

B

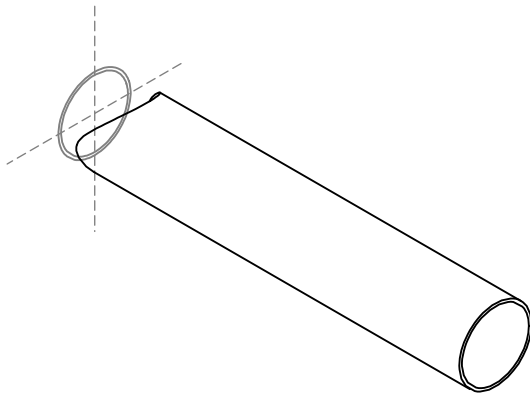
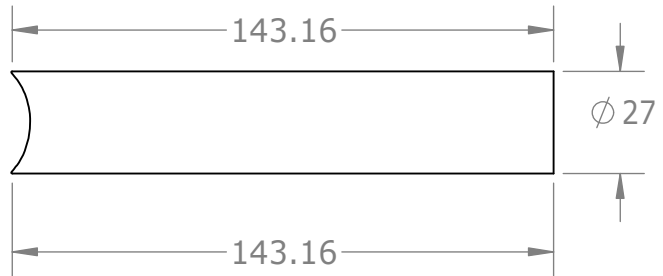
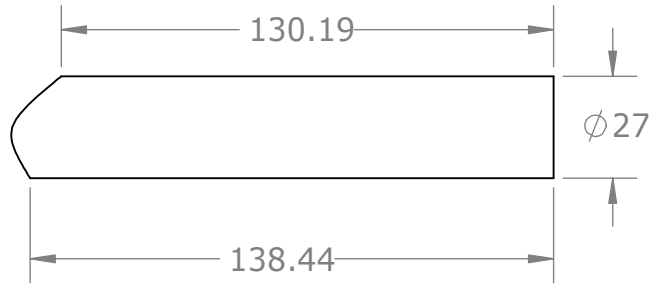
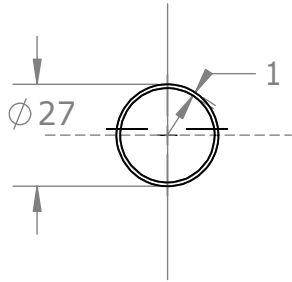

A

A

**PROPRIETARY AND CONFIDENTIAL**

THE INFORMATION CONTAINED IN THIS DRAWING IS THE SOLE PROPERTY OF UNIVERSITY OF STRATHCLYDE. ANY REPRODUCTION IN PART OR AS A WHOLE WITHOUT THE WRITTEN PERMISSION OF UNIVERSITY OF STRATHCLYDE IS PROHIBITED.

**DESCRIPTION:**

CURVED END TO BE WELDED TO TOP OF SEAT TUBE, WITH FLAT END TO BE WELDED TO THE REAR HINGE PART.  
 PART MAKES UP THE REAR PORTION OF TOP TUBE.  
 TIG WELDING REQUIRED.

DIMENSIONS ARE IN MILLIMETRES

TOLERANCES: +3%

MATERIAL: STAINLESS STEEL

SIZE DWG. NO.

**A**

**Back Tube**

REV.

SCALE: 1:2

WEIGHT:

SHEET 1 OF 1

2

1

2

1

B

B

A

A

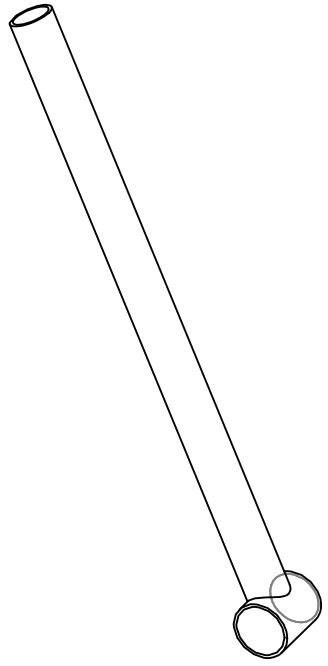
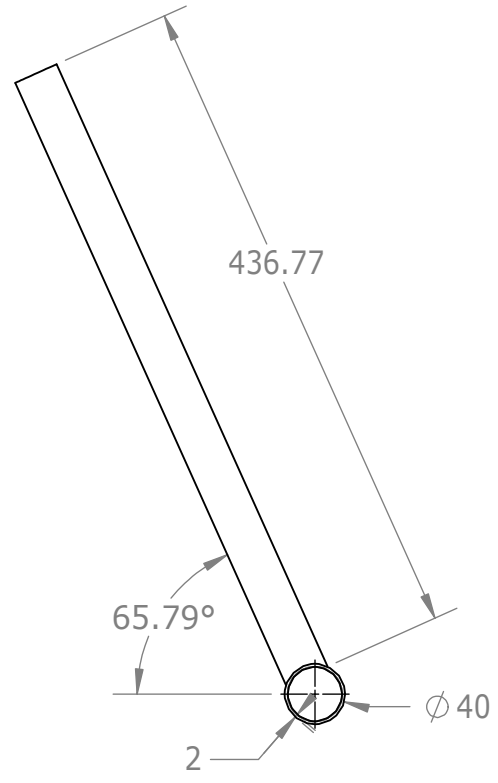
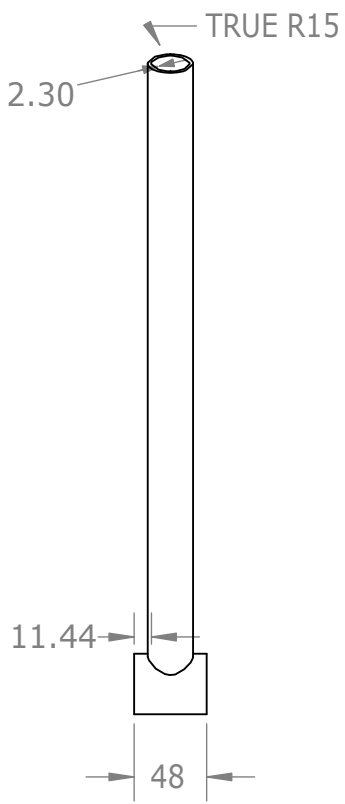

**PROPRIETARY AND CONFIDENTIAL**

THE INFORMATION CONTAINED IN THIS DRAWING IS THE SOLE PROPERTY OF UNIVERSITY OF STRATHCLYDE. ANY REPRODUCTION IN PART OR AS A WHOLE WITHOUT THE WRITTEN PERMISSION OF UNIVERSITY OF STRATHCLYDE IS PROHIBITED.

**DESCRIPTION:**

THE VERTICAL PORTION OF THE SEAT TUBE IS FLAT AT ONE END THEN CUT TO FIT THE OTHER PORTION, WHICH HAS TO BE THREADED AT BRITISH STANDARD THREAD FOR BOTTOM BRACKET BEARINGS. THE SEAT AND CHAINSTAYS TO BE WELDED AT APPROPRIATE PLACES ON SEAT TUBE

TIG WELDING REQUIRED.

DIMENSIONS ARE IN MILLIMETRES

TOLERANCES: +3%

MATERIAL: STAINLESS STEEL

SIZE <b>A</b>	DWG. NO.	REV.
<b>SEAT TUBE</b>		

SCALE: 1:5	WEIGHT:	SHEET 1 OF 1
------------	---------	--------------

2

1



2

1

B

B

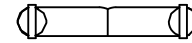
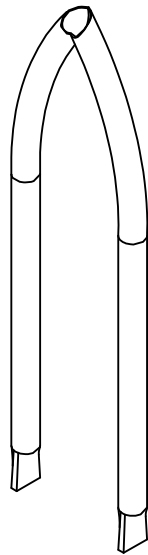
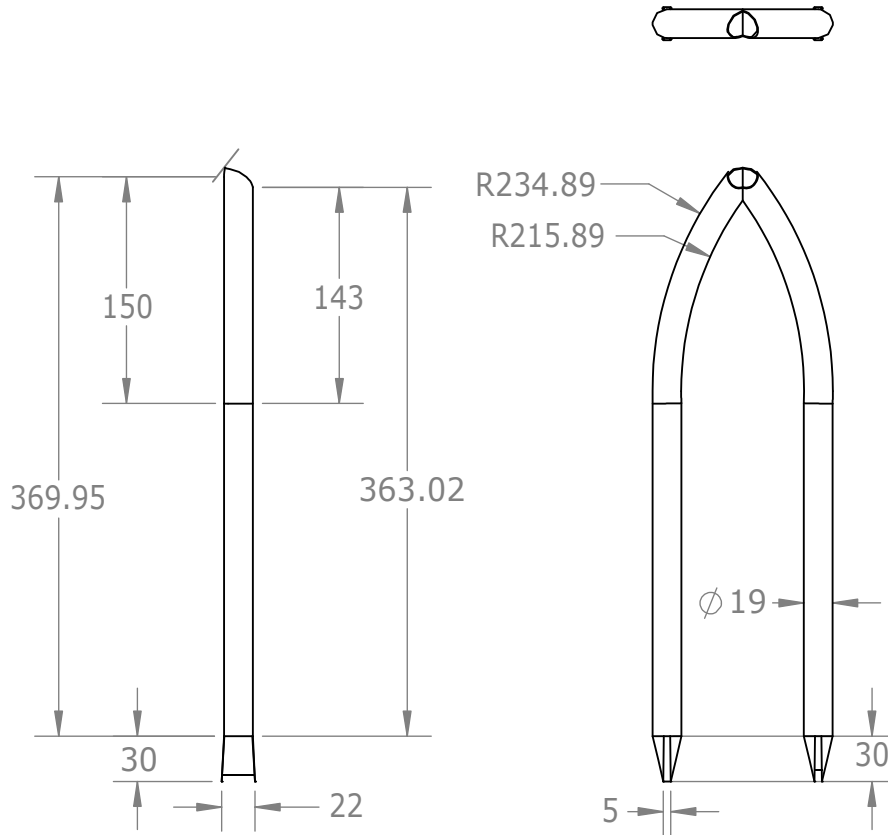

A

A

**PROPRIETARY AND CONFIDENTIAL**

THE INFORMATION CONTAINED IN THIS DRAWING IS THE SOLE PROPERTY OF UNIVERSITY OF STRATHCLYDE. ANY REPRODUCTION IN PART OR AS A WHOLE WITHOUT THE WRITTEN PERMISSION OF UNIVERSITY OF STRATHCLYDE IS PROHIBITED.

**DESCRIPTION:**

SEAT STAY WELDS TO THE UPPER ; ART OF THE REAR DROP OUTS, THEN BENT INTO PLACE AND WELDED TO THE TOP OF THE SEAT TUBE.  
PART MAKES UP THE TOP OF THE REAR TRIANGLE.  
TIG WELDING REQUIRED.

DIMENSIONS ARE IN MILLIMETRES

TOLERANCES: +3%

MATERIAL: STAINLESS STEEL

SIZE DWG. NO.

**A**

**SEATSTAY**

REV.

SCALE:1:5

WEIGHT:

SHEET 1 OF 1

2

1

2

1

B

B

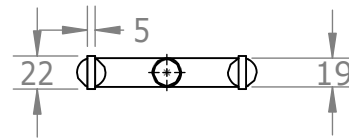
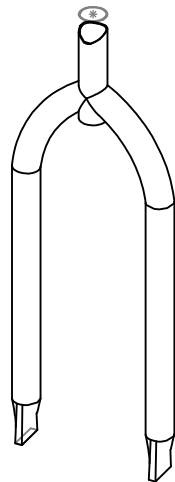
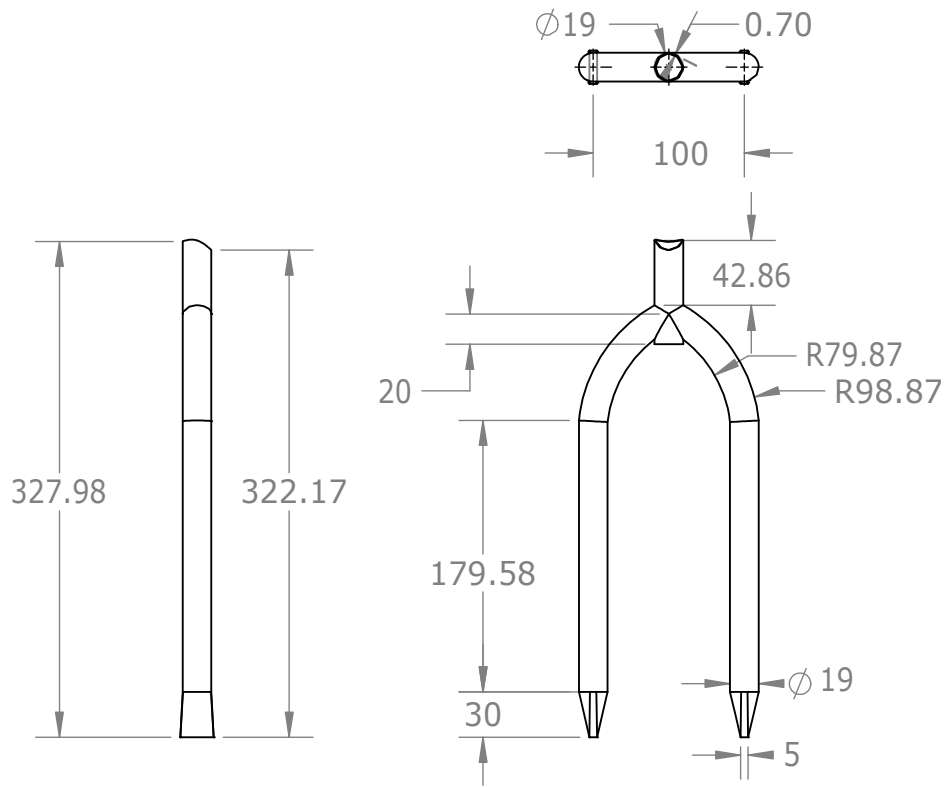

A

A

**PROPRIETARY AND CONFIDENTIAL**

THE INFORMATION CONTAINED IN THIS DRAWING IS THE SOLE PROPERTY OF UNIVERSITY OF STRATHCLYDE. ANY REPRODUCTION IN PART OR AS A WHOLE WITHOUT THE WRITTEN PERMISSION OF UNIVERSITY OF STRATHCLYDE IS PROHIBITED.

**DESCRIPTION:**

CHAINSTAY IS WELDED AT THE REAR TO THE REAR DROP OUTS AND TO THE SEAT TUBE AT THE OTHER END, BENDING MUST TAKE PLACE BEFORE THE WELDS.  
PART MAKES UP BOTTOM OF THE REAR TRIANGLE.  
TIG WELDING REQUIRED.

DIMENSIONS ARE IN MILLIMETRES

TOLERANCES:  $\pm 3\%$

MATERIAL: STAINLESS STEEL

SIZE DWG. NO.

**A**

**Chainstay**

REV.

SCALE: 1:5

WEIGHT:

SHEET 1 OF 1

2

1